

## CONTENTS

<b>1</b>	<b>Introduction.....</b>	<b>1</b>
1.1	Summarization .....	1
1.2	System Requirements .....	3
1.2.1	TD3004~TD3216 Series Cards System Requirements.....	3
1.2.2	TD3304/3308/3316 System Requirements .....	3
1.2.3	TD3101/3104 USB Cards System Requirements .....	4
1.2.4	TD4104 /4404L/4404 Card System Requirements .....	4
1.2.5	TD4116/4316/4416L/4416 Card System Requirements .....	5
1.2.6	TD4108/ 4308/4408/4408L Cards System Requirements .....	6
1.3	System Specifications.....	6
<b>2</b>	<b>Hardware Installation.....</b>	<b>8</b>
2.1	Video Capture Card Hardware .....	8
2.1.1	TD3004 Card Hardware.....	8
2.1.2	TD3304 Card Hardware.....	9
2.1.3	TD3008 Card Hardware.....	10
2.1.4	TD3016 Card Hardware.....	10
2.1.5	TD3116 Card Hardware .....	11
2.1.6	TD3216 Card Hardware.....	12
2.1.7	TD3308 Card Hardware.....	13
2.1.8	TD3316 Card Hardware.....	15
2.1.9	TD3101 USB Card Hardware.....	16
2.1.10	TD3104 USB Card Hardware.....	16
2.1.11	TD4104/4404L/4404 Card Hardware.....	17
2.1.12	TD4116 Card Hardware .....	18
2.1.13	TD4316/4416L Card Hardware .....	20
2.1.14	TD4108/4308/4408/4408L Card Hardware .....	21
2.1.15	Alarm Board Hardware.....	22
2.1.16	Connect Audio Signal .....	23
2.2	Install Video Capture Card Driver .....	23
<b>3</b>	<b>Main Display Interface.....</b>	<b>27</b>
3.1	Display Control Panel.....	27
3.1.1	Display Control Panel .....	27
3.1.2	Display Modes.....	28
3.1.3	Flip Pages .....	28
3.1.4	Auto Dwell Display Mode .....	28
3.1.5	Capture .....	28
3.1.6	Urgent Record.....	28
3.2	Login.....	28
3.3	Record.....	29
3.3.1	Record Modes .....	29
3.3.2	Record Setup .....	29
3.3.3	Record Status Panel.....	30
3.3.4	Manual Record Mode .....	31
3.3.5	Sensor Alarm Record Mode.....	31
3.3.6	Motion Detection Record Mode.....	31
3.3.7	Schedule Record.....	31

3.3.8 Recycling Record .....	32
<b>4 System Setup .....</b>	<b>33</b>
4.1 Basic Configuration .....	33
4.2 Video Configuration .....	35
4.3 Motion Detection Configuration .....	36
4.3.1 Set Motion Detection Area .....	37
4.3.2 Set Motion Detection Area .....	37
4.4 Schedule Configuration .....	38
4.5 Motion Detection Alarm Configuration .....	39
4.5.1 Alarm Triggering Conditions Configuration .....	39
4.5.2 Alarm Record .....	40
4.5.3 Alarm Output .....	40
4.5.4 Auto Mail Function .....	41
4.6 E-map Configuration .....	43
4.6.1 Edit Map .....	43
4.6.2 View Map .....	44
4.7 P.T.Z Control Configuration .....	45
4.7.1 Protocol Setup .....	46
4.7.2 Serial Ports Setup .....	46
4.8 Users Configuration .....	47
4.8.1 Change User rights .....	48
4.8.2 Add User .....	49
4.8.3 Delete User .....	49
<b>5 P.T.Z Control .....</b>	<b>51</b>
<b>6 Record Search &amp; Playing Back .....</b>	<b>55</b>
6.1 Record Search .....	56
6.2 Playing Back and Control .....	57
6.3 Other Functions .....	60
6.3.1 Record File Backup .....	60
6.3.2 Delete Record Files .....	61
6.3.3 Capture Pictures .....	61
6.3.4 Image Zoom in/out .....	63
<b>7 IE Client .....</b>	<b>66</b>
Remote Live Surveillance .....	66
7.1 Remote Surveillance Server Configuration .....	66
7.2 Accessing IE client .....	67
7.3 Remote playing back .....	70
7.3.1 Record play back and control .....	70
7.4 System setup .....	73
7.4.1 Basic Configuration .....	74
7.4.2 Camera setup .....	76
7.4.3 Schedule configuration .....	77
7.4.4 Alarm configuration .....	77
7.4.5 Record configuration .....	78
7.4.6 Motion configuration .....	79
7.4.7 EMAIL Configuration .....	80
7.4.8 P.T.Z Configuration .....	82
7.5 Mobile Surveillance .....	84
7.5.1 Introduction to Mobile Surveillance .....	84
7.5.2 Client Configuration of Windows Mobile .....	85

<b>Appendix1</b>	<b>Frequently Asked Questions.....</b>	<b>90</b>
Appendix 2.1	Installation .....	90
Appendix 2.1.1	Cannot Install the SuperDVR Driver .....	90
Appendix 2.1.2	Why cannot run SuperDVR at the windows 2003 operate system? .....	90
Appendix 2.1.3	Can't find TD series Devices in Device Manager .....	90
Appendix 2.2	How to Use SuperDVR .....	91
Appendix 2.2.1	Meanings of the indicator lights .....	91
Appendix 2.2.2	How does the different record mode work? .....	91
Appendix 2.2.3	How to set recycling record mode on the system .....	91
Appendix 2.2.4	How to set auto reboot function .....	91
Appendix 2.2.5	How to quickly use the schedule record function.....	92
Appendix 2.2.6	What are the byte rates for different image qualities from highest to normal? .....	92
Appendix 2.2.7	The frame rate seems to be lower than what I set?.....	92
Appendix 2.2.8	Why I can't select more channels to backup? .....	92
Appendix 2.3	How to Use Network Function .....	92
Appendix 2.3.1	How to monitor on the client-side.....	92
Appendix 2.3.2	Why I can't download the client-side software?.....	92
Appendix 2.3.3	Why can't the server be configured at the client-side? .....	93
Appendix 2.3.4	Why I can't see the images?.....	93
Appendix 2.3.5	What should I do if the Internet speed is quite slow?.....	93
Appendix 2.3.6	Why I can't start WebCam server or RPB server?.....	93
Appendix 2.4	Other Questions .....	94
Appendix 2.4.1	Why computer display doesn't work, and why I can't access window system? .....	94
Appendix 2.4.2	Why I can't find the recorded files?.....	94
Appendix 2.4.3	Why the screens display is unstable with dithering and water-wave images? .....	94
Appendix 2.4.4	Why does it delay to play back, and it's slow to close and open the driver?... ..	94
Appendix 2.4.5	Why I can't play back? .....	94
Appendix 2.4.6	Why do I see some gray blocks on time progress bar area when play back? .....	94
Appendix 2.4.7	Why could I see some old record sections that didn't be covered when playing back? .....	95
Appendix 2.4.8	Precautions on changing system time .....	95
Appendix 2.4.9	If system time must be changed, please do following preparations first.....	95
Appendix 2.4.10	How to use REPAIRDB to repair SuperDVR database .....	95
Appendix 2.4.11	How to set power options of Microsoft VISTA system .....	95
<b>Appendix2</b>	<b>Quick Start for Using .....</b>	<b>96</b>
Appendix 3.1	Requirements .....	96
Appendix 3.2	Installation Instructions .....	96
Appendix 3.3	Troubleshooting .....	97
Appendix3.3.1	When opening the SuperDVR program, it says ' Can't find card '. .....	97
Appendix 3.3.2	How to setup the web client to monitor from Internet.....	97
<b>Appendix3</b>	<b>Function Tree.....</b>	<b>99</b>
Appendix 4.1	SuperDVR Function Tree .....	99
Appendix 4.2	System Configuration Tree .....	100
Appendix 4.3	IE Client Function Tree .....	101
Appendix 4.4	Remote Playback Function Tree.....	102

## FIGURES

Figure2-1	TD3004 Video Capture Card.....	8
Figure2-2	TD3304 Video Capture Card.....	9
Figure2-3	TD3008 Video Capture Card.....	10
Figure2-4	Pins Definitions of TD3008 Video Capture Card.....	10
Figure2-5	TD3016 Video Capture Card Circuit Link for Watchdog Function.....	10
Figure2-6	TD3016 Video Capture Card Alarm Port .....	11
Figure2-7	TD3116 Video Capture Card.....	11
Figure2-8	Reset Pins Definitions of TD3116 Video Capture Card .....	12
Figure2-9	Pins Definitions of TD3116 Video Capture Card.....	12
Figure2-10	TD3216 Video Capture Card.....	12
Figure2-11	Pins Definitions of TD3216 Video Capture Card.....	13
Figure2-12	TD3308 Video Capture Card.....	13
Figure2-13	Video Connector and Pins Definition.....	14
Figure2-14	TD3308 Video Capture Card Alarm Port .....	14
Figure2-15	TD3316 Video Capture Card.....	15
Figure2-16	Audio Connector and Pins Definition.....	15
Figure2-17	Video Pins Definition .....	16
Figure2-18	TD3101 USB Video Capture Card .....	16
Figure2-19	TD3104 USB Video Capture Card .....	16
Figure2-20	TD4104/4404L/4404 Video Capture Card .....	17
Figure2-21	Definition of Audio and Video Connector's Pins.....	17
Figure2-22	Multi-Card Connection.....	18
Figure2-23	TD4116 Video Capture Card.....	18
Figure2-24	Audio Connector and Pins Definition.....	19
Figure2-25	Video Pins Definition .....	19
Figure2-26	TD4316/4416L Video Capture Card .....	20
Figure2-27	Definition of Audio Connector and Pins .....	20
Figure2-28	TD4108/4308/4408/4408L Video Capture Card.....	21
Figure2-29	Definition of Audio and Video Connector's Pins.....	21
Figure2-30	Multi-Card Connection.....	22
Figure2-31	Alarm Board .....	22
Figure2-32	Pins Definition of Alarm Board .....	22
Figure2-33	TD Series Video Capture Card Installation Interface .....	23
Figure2-34	Welcome Page .....	24
Figure2-35	Select Video Format .....	24
Figure2-36	Rate of Progress of Driver Installation.....	24
Figure2-37	Select Installation Folder .....	25
Figure2-38	Register Application.....	25
Figure2-39	Driver and Application Installation Finished .....	26
Figure2-40	Shortcut of SuperDVR .....	26
Figure2-41	Install the Software on VISTA .....	26
Figure3-1	SuperDVR Main Display Interface.....	27
Figure3-2	Display Control Panel.....	27
Figure3-3	Display Modes Panel.....	28
Figure3-4	Main Interface .....	29
Figure3-5	Record Configuration Panel.....	29
Figure3-6	Record Status Panel & Alarm Output Status Panel.....	30
Figure4-1	Basic Configuration .....	33
Figure4-2	Caption and General Configuration.....	34
Figure4-3	Record Data Storage Precept .....	34

Figure4-4	Computer System Reboot Setup .....	35
Figure4-5	Video Configuration .....	36
Figure4-6	Motion Detection Configuration.....	37
Figure4-7	Schedule Configuration .....	38
Figure4-8	Edit Schedule .....	39
Figure4-9	Local Alarm Triggering Configuration .....	39
Figure4-10	Alarm Trigger Method Configuration .....	40
Figure4-11	Alarm Output Configuration .....	40
Figure4-12	Auto Mail Setup Interface .....	42
Figure4-13	Auto Mail Setup .....	42
Figure4-14	Attachment Setup.....	43
Figure4-15	E-Map Edit .....	44
Figure4-16	View Camera.....	45
Figure4-17	PTZ Configuration Panel .....	46
Figure4-18	P.T.Z Protocol Setup .....	46
Figure4-19	P.T.Z Serial Port Setup.....	47
Figure4-20	User configuration .....	48
Figure4-21	User Password and Rights Edit .....	48
Figure4-22	Add User.....	49
Figure4-23	Confirm Delete User .....	50
Figure5-1	P.T.Z Control Interface .....	51
Figure5-2	P.T.Z Control Function Buttons Panel.....	51
Figure5-3	Speed Adjustment .....	52
Figure5-4	Preset and Group Select .....	53
Figure5-5	Preset .....	53
Figure5-6	Group Configuration .....	54
Figure6-1	Search and Playback Interface .....	55
Figure6-2	Record Search Area .....	56
Figure6-3	Playing Back and Control .....	57
Figure6-4	Play Speed Controller.....	58
Figure6-5	Record Files Browser .....	58
Figure6-6	Multiple Channels Playing Back Control.....	58
Figure6-7	Channel Configuration Dialog for Single Channel Playing Back Mode.....	59
Figure6-8	Channel Configuration Dialog for 4-channel Playing Back Mode .....	59
Figure6-9	Channel Configuration Dialog for 9-channel Playing Back Mode .....	59
Figure6-10	Channel Configuration Dialog for 16-channel Playing Back Mode .....	60
Figure6-11	Recorded Files Backup.....	60
Figure6-12	Delete Recorded Files .....	61
Figure6-13	Color Control Panel .....	62
Figure6-14	Capture Multiple Images in Sequence.....	62
Figure6-15	Print Setup .....	62
Figure6-16	Print Preview .....	63
Figure6-17	Example: original size.....	64
Figure6-18	Example: zoomed out.....	64
Figure6-19	Example: zoomed in.....	65
Fig 7.1	WebCam Server Configuration .....	66
Fig 7.2	WebCam install interface.....	67
Fig 7.3	WebCam Login interface .....	68
Fig 7.4	WebCam Main interface .....	68
Fig 7.5	Remote play back .....	70
Fig 7.6	Remote backup.....	71
Fig 7.7	Channel configuration window for 1 channel play back mode.....	72
Fig7.8	Channel configuration window for 4 channel playback mode .....	72
Fig 7.9	Data Preview.....	72
Fig 7.10	Basic Configuration .....	74
Fig 7.11	Basic setup.....	74

Fig 7.12 Computer System Reboot Setup .....	75
Fig 7.13 Alarm triggering configuration .....	75
Fig 7.14 Camera setup configuration.....	76
Fig 7.15 Schedule configuration .....	77
Fig 7.16 Alarm configuration.....	77
Fig 7.17 Record configuration .....	78
Fig 7.18 Record setup.....	78
Fig 7.21 Email configuration.....	81
Fig 7.22 Mail server setup .....	81
Fig 7.23 Mail setup .....	82
Fig 7.24 Attachment setup.....	82
Fig 7.25 P.T.Z Configuration .....	83
Fig 7.26 P.T.Z Protocol setup .....	83
Fig 7.27 P.T.Z Serial port setup .....	84
Fig 7.28 Open Web Brower.....	85
Fig 7.29 Build a bookmark .....	86
Fig 7.30 Connect to Server .....	86
Fig 7.31 Confirmation Information Window .....	86
Fig 7.32 Installing Configuration Information.....	87
Fig 7.33 Scam Shortcut icon in System Menu .....	87
Fig 7.34 Main Layout of Scam.....	87
Fig 7.35 Configuration Login Information.....	88
Fig 7.36 Log in Successfully.....	88
Fig 7.37 Alarm Setting.....	88

## TABLES

Table1-1 TD3004~TD3216 Series Cards System Requirements.....	3
Table1-2 TD3304/3308/316 System Requirements.....	4
Table1-3 TD3101/3104 System Requirements .....	4
Table1-4 TD4104/4404L/4404 System Requirements.....	4
Table1-5 TD4116 /4316/4416L/4416System Requirements .....	5
Table1-6 Motherboards and VGA Cards Support XP OS .....	6
Table1-7 Motherboards and VGA Cards Support VISTA OS .....	6
Table1-8 TD4108/ 4308/4408/4408L System Requirements .....	6
Table2-1 TD3004 Card Pins .....	8
Table2-2 TD3304 Card Pins .....	9
Table2-3 Pins Definitions of TD3016 Card.....	11
Table2-4 Pins Definitions of TD3308 Card.....	14
Table 7-1 Mobile Phone of Supporting Mobile Surveillance.....	85

# 1 Introduction

## 1.1 Summarization

Thank you for choosing our digital video capture cards.

1Channel, 4 Channel, 9 Channel, 16 Channel and 32 Channel cards adopt H.264 compression format, and enable maximum 32 channels real-time or none real-time surveillance. Our cards are mature and cost-effective products that should be your ideal choices. They enable synchronous audio and video compression and transmission, with their powerful compression rate and network transmission function. They are widely used in banks, intelligent communities, traffic management units, medical systems, educational systems, armed forces and so on.

This manual is suitable for SuperDVR, which supports TD3004, TD3008, TD3016, TD3101, TD3104, TD3116, TD3216, TD3304, TD3308, TD3316, TD4104, TD4116, TD4108, TD4308, TD4316, TD4404, TD4404L, TD4408, TD4408L and TD4416L cards.

In this manual, you will learn how to install the hardware and driver (software), and how to setup the systems of this range of products. Please make sure your operations with the products are strictly in accordance with the manual, so as to keep the stability of the digital surveillance systems.

The following are standard functions of the products:

- **Schedule record mode**  
Users can choose any term in a day to record and set up record modes, i.e. sensor alarm record, motion detection record, manual record, Schedule Record.
- **Motion detection mode**  
Motion detection areas are adjustable and maximum 16 areas for each channel. Users can also set motion detection sensitivity for each channel. The system begins to record only when motion of the detected object

happens, and it will stop recording after a certain period, this function is adjustable by users.

- Sensor alarm record mode  
With extra alarm board, the system enables alarm input and output.
- Recycling record mode  
Users can set recording storage sequence for HDD partitions. The recording storage will automatically swap to the next partition when it is full. If all the partitions are full and recycling record mode is enabled, the former recorded data will be covered by new data. Users can also set HDD minimum storage alarm. Then once the present storage space is less than the minimum storage and recycling record mode is not enabled, the record will automatically stop.
- P.T.Z control function  
Support a number of decoders. Users can control multiple speed domes and integrative cameras, including pan, tilt, zoom, and focus and iris adjustment for P.T.Z devices. Support preset point and auto scout.
- Users management  
Different users have different rights, user names and passwords, so as to ensure system security.
- Multi-channel display  
Support different multi-channel display modes, full screen display and auto dwell display.
- Watch dog function  
The 16 Channels card has watchdog function. In case SuperDVR driver or windows system is frozen, the watchdog will restart the computer and login SuperDVR system again automatically.
- One PC support 1 to 4 cards of the same model, the maximum frame rate can be 800 fps and 32 channels at most.
- Support 320x240 / 640x480 (NTSC), 352x288 / 704x576(PAL) standard resolutions.
- Image color adjustable for each channel, including contrast, lightness, hue and saturation.
- H.264 compression format, greatly reduce HDD usage
- Powerful video playing back functions, including playing back, pause, stop, fast-forward, single-frame play and image capture.
- Support advanced search mode. Users can search by date/time, camera, record mode, and random combination of the three methods.
- Support recorded files backup, delete by date/time, camera.
- Convenient to extend system functions by software upgrade.
- Supply multiple languages, including Chinese (Traditional), English, German, Spanish, Portuguese and other customized languages.
- CPU and storage resources saving by advanced technology



- Remote Surveillance and P.T.Z control through LAN, Intranet, and Internet.
- Support alarm pre-record.
- Support buzzer, email alarm out.
- Can greatly decrease fragmented files while using NTFS partition.
- User-friendly graphical user interface.

## 1.2 System Requirements

Our TD series video card support running on Windows VISTA OS. And the computer which connected the TD series video card required that motherboard and VGA card could support Windows VISTA OS.

### 1.2.1 TD3004~TD3216 Series Cards System Requirements

PC Module \ Card	TD3004, TD3008, TD3016, TD3116, TD3216
CPU	Intel PIII processor, minimum 800MHz
Motherboard	Intel 815/845/865/915 series
HDD	80G minimum
RAM	256M minimum
VGA	GeForce2, GeForce4, FX5200, ATI Rage128
OS	Windows2000 /XP /VISTA
DirectX	9.0

Table1-1 TD3004~TD3216 Series Cards System Requirements

#### NOTICE

Notice motherboards listed below which has passed the test can work well with TD3004~TD3216:

- GIGA: GA-8IRXI (Intel 845D)
- GA-8IE2004 (Intel 845E)
- GA-6OXT (Intel 815EP)
- GA-8PE800 (Intel 845PE)
- GA-8IPE1000-G (Intel 865PE)
- ASUS: P4S8X (Sis 648)
- TUSL2-C (Intel 815EP)
- P4P800 (Intel 865PE)
- MSI: MS-6566E (Intel 845E)
- Intel845DDA+ (Intel 845E)

### 1.2.2 TD3304/3308/3316 System Requirements

PC Module \ Card	TD3304,TD3308, TD3316
CPU	Intel P4 2.8G minimum
Motherboard	Intel 865/915
HDD	160G minimum
RAM	512M minimum
VGA	NVIDIA GeForce MX440/FX5200 ATI RADEON 7500/ X300/ X250/ X5518

Fout! Gebruik het tabblad Start om  
 标题 1 toe te passen op de tekst die  
 u hier wilt weergeven. Fout!  
 Gebruik het tabblad Start om 标题  
 1 toe te passen op de tekst die u hier  
 wilt weergeven.

OS	Windows 2000(SP4 above) /Windows XP(SP2 above) /VISTA
DirectX	9.0

**Table1-2 TD3304/3308/3316 System Requirements**

**NOTICE**

- 1.The computer which installed TD3316 video card requires that motherboard and VGA card could support Window VISTA OS.
- 2.Motherboards listed below which has passed the test can work well with TD3316:
  - Foxconn 865A01(Intel 865)
  - Ga-81pe1000-G 865(Intel 865)
  - Asus P4p800 865(Intel 865)
  - ASUS P5GD1-VM 915(Intel 915)
  - MSI 6728 865(Intel 865)
  - Abit IS7-E 865(Intel 865)
  - ASUS-P4GPL-X 915(Intel 915)
  - ASROCK 775I915PL-SATA2 915(Intel 915)
- 3.At present, TD3304/TD3308 not support three motherboards: ASUS P5LD2-X, Intel965G and GIGABYTE EP45-UD3L.

**1.2.3 TD3101/3104 USB Cards System Requirements**

PC Module \ Card	TD3101, TD3104
CPU	Intel P4 Celeron processor, minimum 1700MHz
Motherboard	Intel 845/865/915 series
HDD	80G minimum
RAM	256M minimum
VGA	GeForce2, GeForce4, FX5200, ATI Rage128
OS	Windows 2000(SP4 above) /2003(SP2 above) /XP(SP2 above) /VISTA
DirectX	9.0
USB	2.0

**Table1-3 TD3101/3104 System Requirements**

**1.2.4 TD4104 /4404L/4404 Card System Requirements**

PC Module \ Card	TD4104, TD 4404L, TD 4404
CPU	Intel P4 Celeron processor 2.0G minimum
HDD	80G minimum
RAM	256M minimum
OS	Windows 2000 /2003 /XP /VISTA
DirectX	9.0

**Table1-4 TD4104/4404L/4404 System Requirements**

**NOTICE**

1. Motherboards listed below which have passed the test can work well with TD4104:
  - Intel 865G
  - GA-945PL-S3E
  - GA965P-S3
  - GA-K8V7890-9
  - GA-8IE2004P
  - ASUS P5PL2
  - ASUS P5B-E
2. VGA cards listed below which have passed the test can work well with TD4104:
  - ATI X1600
  - ATI X300
  - NVIDIA Geforce 7300LE
  - NVIDIA Geforce 7600GS
  - NVIDIA Geforce 8500GT

If recorded disk partition's format is FAT32 and the system has run for a long time, the system will create a lot of data fragments that may results in system runs slowly. It's recommended to make disk defragmenter every 10 to 30 days. We strongly suggest that use NTFS format for record disk partition.

### 1.2.5 TD4116/4316/4416L/4416 Card System Requirements

PC Module	Card TD4116,TD 4316,TD 4416L,TD 4416 *one card	TD4116,TD 4316,TD 4416L,TD 4416 *two cards
CPU	Intel P4 Celeron processor 3.0G minimum	Intel PD Dual-core 2.8 G above
HDD	80G minimum	160G minimum
RAM	1G minimum	2.0G minimum
OS	Windows 2000/2003/XP/VISTA	
DirectX	9.0	

Table1-5 TD4116 /4316/4416L/4416System Requirements

Motherboards and VGA cards listed below which have passed the test can work well with TD4116 in Windows XP system:

Motherboard	VGA card
COLORFUL C975X-MVP	ATI HD2400
	NVIDIA GeForce 7600
	NVIDIA GeForce 7300
ASUS P5LD2-X	ATI HD2400
	ATI X300
ASUS P5B	ATI HD2400
	NVIDIA GeForce 7600
	NVIDIA GeForce 7300
	ATI X300
GA-965P-S3	ATI HD2400
	NVIDIA GeForce 7300
	ATI X300
GA-945PL-S3E	ATI HD2400
	NVIDIA GeForce 7600

Motherboard	VGA card
ASUS P5L-1394	ATI X300
	ATI HD2400
	NVIDIA GeForce 7600
ASUS P5GD1-VM	ATI X300
	ATI HD2400
	NVIDIA GeForce 7600
	ATI X300
	ATI X700

Table1-6 Motherboards and VGA Cards Support XP OS

Motherboards and VGA cards listed below which have passed the test can work well with TD4116 in Windows VISTA system:

Motherboard	VGA card
COLORFUL C975X-MVP	ATI HD2400
ASUS P5LD2-X	ATI HD2400
	ATI X300
GA-965P-S3	ATI HD2400
	ATI X300
ASUS P5L-1394	ATI HD2400
	ATI X300
ASUS P5GD1-VM	ATI HD2400
	ATI X300
	ATI X700

Table1-7 Motherboards and VGA Cards Support VISTA OS

### 1.2.6 TD4108/ 4308/4408/4408L Cards System Requirements

PC Module	Card	TD4108,TD4308, TD4408,TD4408L *one card	TD4108,TD4308, TD4408,TD4408L *four cards
CPU		Intel P4 Celeron processor 3.0G minimum	Intel PD Dual-core 2.8 G above
HDD		80G minimum	160G minimum
RAM		512M minimum	2.0G minimum
OS		Windows 2000/2003/XP/VISTA	
DirectX		9.0	

Table1-8 TD4108/ 4308/4408/4408L System Requirements

## 1.3 System Specifications

- Format: PAL/NTSC.
- Resolution: TD3004, 3008, 3016, 3116, 3216, 3101, 3104 support 320x240 / 640x480 (NTSC), 352x288 / 704x576(PAL),TD3304,3308 support 320x240(NTSC), 352x288(PAL),TD3316 supports 352 × 240 / 704 × 480(NTSC), 352x288 / 704x576(PAL) ,TD4104 supports 320×240(NTSC) , 352×288(PAL) ,TD4108 supports 320×240(NTSC) , 352×288(PAL) and TD 4308,4316,4404,4404L,4408,4408L,4416L supports 704x576(PAL).

- Maximum Frame rate per channel: 25 fps (PAL), 30 ftp (NTSC).
- Screen set: resolution 1024×768, color quality 16 bits or 32 bits.
- Compression code rate: 50kbps – 1.2Mbps.
- Data format: H.264

# 2 Hardware Installation

## 2.1 Video Capture Card Hardware

### 2.1.1 TD3004 Card Hardware

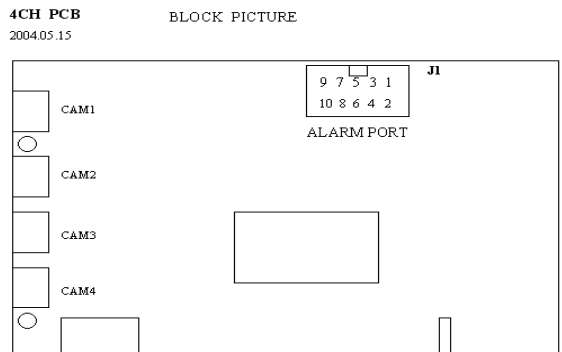

Figure2-1 TD3004 Video Capture Card

Pin Port	Define	Interpret
1PIN	5V	Power Source (5V)
2PIN	ALARM_COM	Alarm COM
3PIN	ALARM_NC	Alarm Normal Close
4PIN	ALARM_IN1	Alarm Input 1
5PIN	ALARM_NO	Alarm Normal Open
6PIN	ALARM_IN2	Alarm Input 2
7PIN	GND	Ground
8PIN	ALARM_IN3	Alarm Input 3
9PIN	GND	Ground
10PIN	ALARM_IN4	Alarm Input 4

Table2-1 TD3004 Card Pins

### 2.1.2 TD3304 Card Hardware

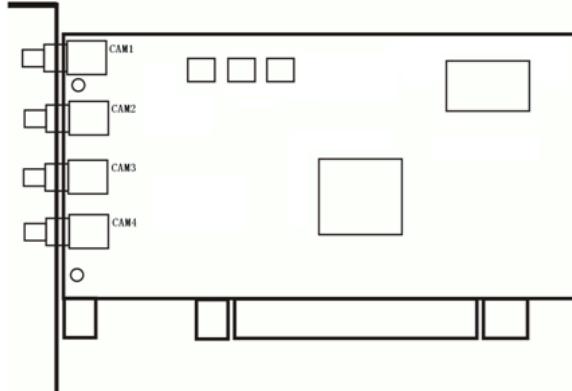

Figure2-2 TD3304 Video Capture Card

Pin Port	Define	Interpret
1PIN	5V	Power Source (5V)
2PIN	ALARM_COM	Alarm COM
3PIN	ALARM_NC	Alarm Normal Close
4PIN	ALARM_IN1	Alarm Input 1
5PIN	ALARM_NO	Alarm Normal Open
6PIN	ALARM_IN2	Alarm Input 2
7PIN	GND	Ground
8PIN	ALARM_IN3	Alarm Input 3
9PIN	GND	Ground
10PIN	ALARM_IN4	Alarm Input 4

Table2-2 TD3304 Card Pins

### 2.1.3 TD3008 Card Hardware

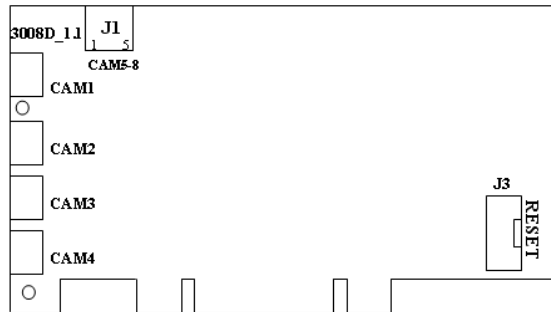

Figure2-3 TD3008 Video Capture Card

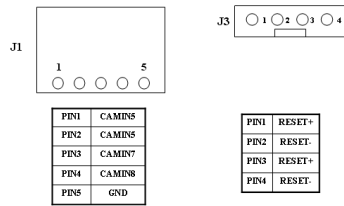

Figure2-4 Pins Definitions of TD3008 Video Capture Card

### 2.1.4 TD3016 Card Hardware

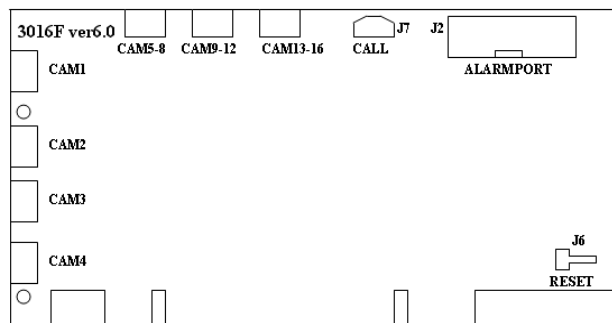
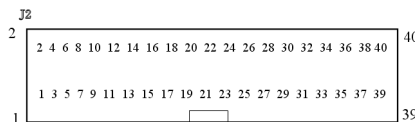

Figure2-5 TD3016 Video Capture Card Circuit Link for Watchdog Function





**Figure2-6 TD3016 Video Capture Card Alarm Port**

The Alarm Port pin definitions of TD3016 Card are as below:

Pin Port	Define	Interpret	Pin Port	Define	Interpret
Pin1	Alarm_in1	Alarm Input 1	Pin21	Alarm_out5	Alarm Output 5
Pin2	Alarm_in2	Alarm Input 2	Pin22	Alarm_out6	Alarm Output 6
Pin3	Alarm_in3	Alarm Input 3	Pin23	Alarm_out7	Alarm Output 7
Pin4	Alarm_in4	Alarm Input 4	Pin24	Alarm_out8	Alarm Output 8
Pin5	Alarm_in5	Alarm Input 5	Pin25	Alarm_out9	Alarm Output 9
Pin6	Alarm_in6	Alarm Input 6	Pin26	Alarm_out10	Alarm Output 10
Pin7	Alarm_in7	Alarm Input 7	Pin27	Alarm_out11	Alarm Output 11
Pin8	Alarm_in8	Alarm Input 8	Pin28	Alarm_out12	Alarm Output 12
Pin9	Alarm_in9	Alarm Input 9	Pin29	Alarm_out13	Alarm Output 13
Pin10	Alarm_in10	Alarm Input 10	Pin30	Alarm_out14	Alarm Output 14
Pin11	Alarm_in11	Alarm Input 11	Pin31	Alarm_out15	Alarm Output 15
Pin12	Alarm_in12	Alarm Input 12	Pin32	Alarm_out16	Alarm Output 16
Pin13	Alarm_in13	Alarm Input 13	Pin33	Alarm_Com	Alarm COM
Pin14	Alarm_in14	Alarm Input 14	Pin34	Alarm_NO	Alarm Normal Open
Pin15	Alarm_in15	Alarm Input 15	Pin35	Alarm_NC	Alarm Normal Close
Pin16	Alarm_in16	Alarm Input 16	Pin36	GND	Ground
Pin17	Alarm_out1	Alarm Output 1	Pin37	GND	Ground
Pin18	Alarm_out2	Alarm Output 2	Pin38	5V	Power Source (5V)
Pin19	Alarm_out3	Alarm Output 3	Pin39	Not Used	Not Used
Pin20	Alarm_out4	Alarm Output 4	Pin40	Not Used	Not Used

**Table2-3 Pins Definitions of TD3016 Card**

### 2.1.5 TD3116 Card Hardware

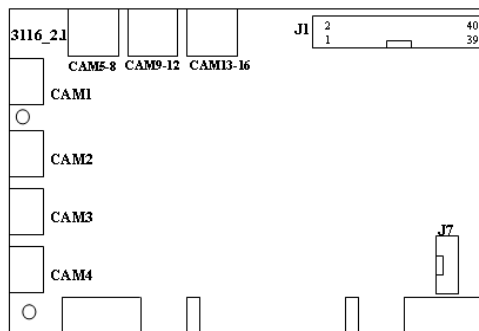

**Figure2-7 TD3116 Video Capture Card**

Fout! Gebruik het tabblad Start om 标题 1 toe te passen op de tekst die u hier wilt weergeven. Fout!  
 Gebruik het tabblad Start om 标题 1 toe te passen op de tekst die u hier wilt weergeven.

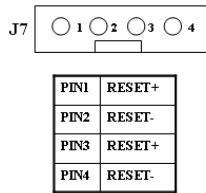

Figure2-8 Reset Pins Definitions of TD3116 Video Capture Card



PIN1	AI1	PIN9	AI9	PIN17	AO1	PIN25	AO9	PIN33	ALAM-COM
PIN2	AI2	PIN10	AI10	PIN18	AO2	PIN26	AO10	PIN34	ALAM-NO
PIN3	AI3	PIN11	AI11	PIN19	AO3	PIN27	AO11	PIN35	ALAM-NC
PIN4	AI4	PIN12	AI12	PIN20	AO4	PIN28	AO12	PIN36	GND
PIN5	AI5	PIN13	AI13	PIN21	AO5	PIN29	AO13	PIN37	GND
PIN6	AI6	PIN14	AI14	PIN22	AO6	PIN30	AO14	PIN38	5V
PIN7	AI7	PIN15	AI15	PIN23	AO7	PIN31	AO15	PIN39	NOT USED
PIN8	AI8	PIN16	AI16	PIN24	AO8	PIN32	AO16	PIN40	NOT USED

Figure2-9 Pins Definitions of TD3116 Video Capture Card

### 2.1.6 TD3216 Card Hardware

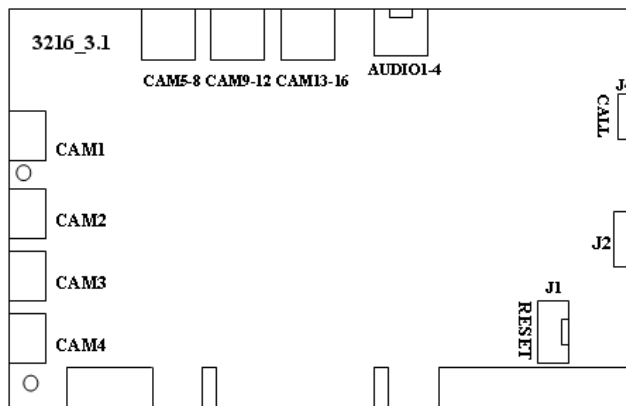

Figure2-10TD3216 Video Capture Card

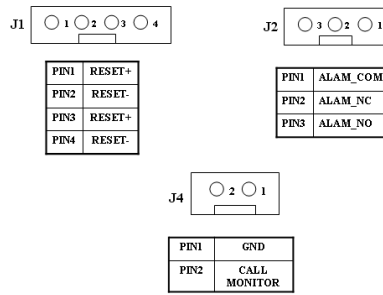

Figure2-11 Pins Definitions of TD3216 Video Capture Card

### 2.1.7 TD3308 Card Hardware

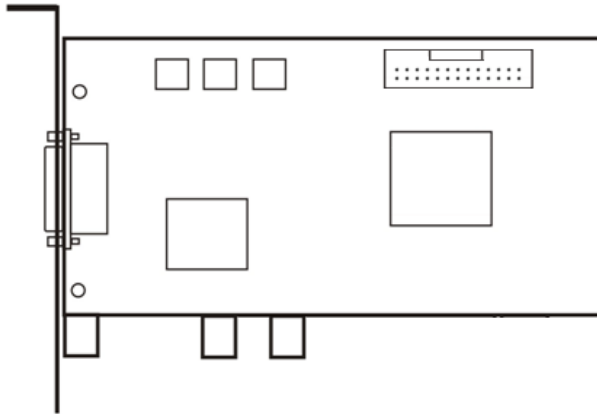
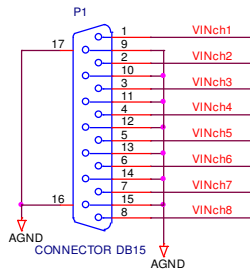

Figure2-12TD3308 Video Capture Card



PIN1	Video1	PIN6	Video6
PIN2	Video2	PIN7	Video7
PIN3	Video3	PIN8	Video8

Fout! Gebruik het tabblad Start om 标题 1 toe te passen op de tekst die u hier wilt weergeven. Fout!  
 Gebruik het tabblad Start om 标题 1 toe te passen op de tekst die u hier wilt weergeven.

PIN4	Video4	Pin9-pin15	GND
PIN5	Video5		

Figure2-13 Video Connector and Pins Definition



Figure2-14 TD3308 Video Capture Card Alarm Port

Pin Port	Define	Interpret	Pin Port	Define	Interpret
Pin1	Alarm_in1	Alarm Input 1	Pin21		
Pin2	Alarm_in2	Alarm Input 2	Pin22		
Pin3	Alarm_in3	Alarm Input 3	Pin23		
Pin4	Alarm_in4	Alarm Input 4	Pin24		
Pin5	Alarm_in5	Alarm Input 5	Pin25		
Pin6	Alarm_in6	Alarm Input 6	Pin26		
Pin7	Alarm_in7	Alarm Input 7	Pin27		
Pin8	Alarm_in8	Alarm Input 8	Pin28		
Pin9			Pin29		
Pin10			Pin30		
Pin11			Pin31		
Pin12			Pin32		
Pin13			Pin33		
Pin14			Pin34	Alarm_Com	Alarm COM
Pin15			Pin35	Alarm_NO	Alarm Normal Open
Pin16			Pin36	GND	Ground
Pin17			Pin37	GND	Ground
Pin18			Pin38	5V	Power Source (5V)
Pin19			Pin39	Alarm_NC	Alarm Normal Close
Pin20			Pin40		

Table2-4 Pins Definitions of TD3308 Card

### 2.1.8 TD3316 Card Hardware

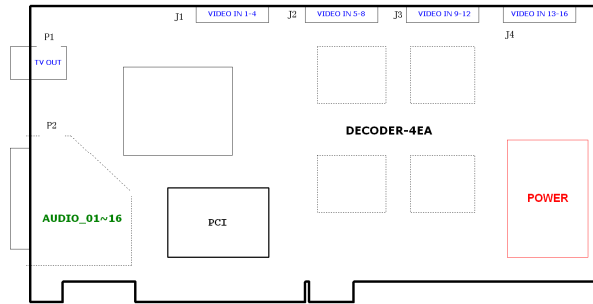
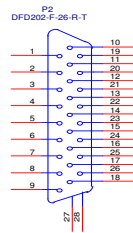
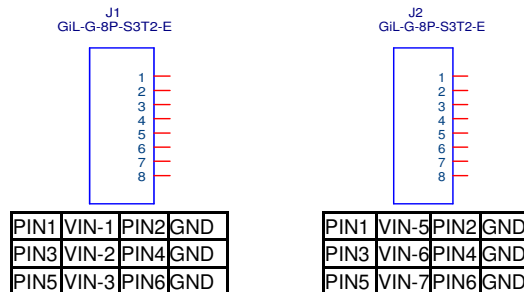

Figure2-15TD3316 Video Capture Card



PIN1	AUDIO2	PIN11	AUDIO3
PIN2	AUDIO4	PIN12	AUDIO5
PIN3	AUDIO6	PIN13	AUDIO7
PIN4	AUDIO8	PIN14	AUDIO9
PIN5	AUDIO10	PIN15	AUDIO11
PIN6	AUDIO12	PIN16	AUDIO13
PIN7	AUDIO14	PIN17	GND
PIN8	AUDIO15		
PIN9	AUDIO16	/	
PIN10	AUDIO1	PIN26	

Figure2-16Audio Connector and Pins Definition



Fout! Gebruik het tabblad Start om 标题 1 toe te passen op de tekst die u hier wilt weergeven. Fout!  
 Gebruik het tabblad Start om 标题 1 toe te passen op de tekst die u hier wilt weergeven.

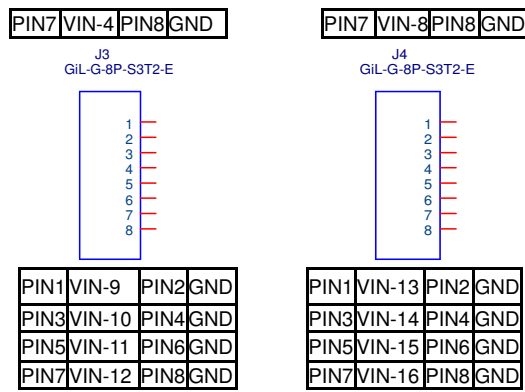

Figure2-17Video Pins Definition

### 2.1.9 TD3101 USB Card Hardware

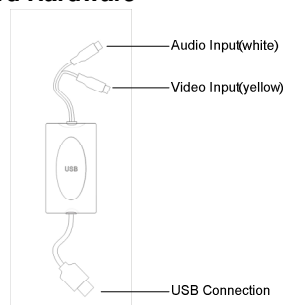

Figure2-18 TD3101 USB Video Capture Card

### 2.1.10 TD3104 USB Card Hardware

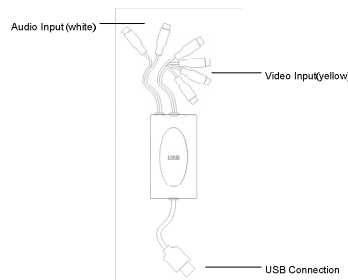

Figure2-19TD3104 USB Video Capture Card

**NOTICE**

- Make sure that your PC USB interface is 2.0.

- TD3101/3104 card can only support USB 2.0.

Please accord to the following steps to safely remove the USB card: Right clicks on the Taskbar Stop device pull out the USB card.

Using TD3101/3104 card with other USB device simultaneously may cause PC cannot identify USB card.

Do not insert two or more USB video capture cards simultaneously.

Do not use with the other PCI video capture card simultaneously.

### 2.1.11 TD4104/4404L/4404 Card Hardware

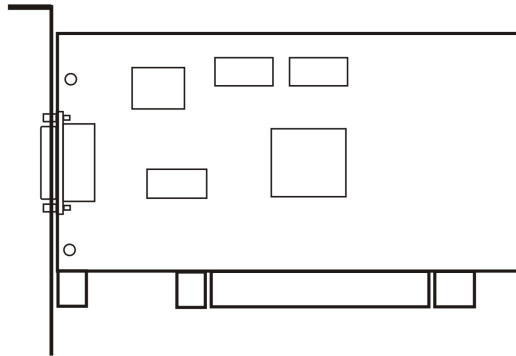
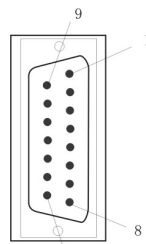

Figure2-20TD4104/4404L/4404 Video Capture Card



PIN1	VIDEO-1	PIN9	GND
PIN2	GND	PIN10	AUDIO-1
PIN3	VIDEO-2	PIN11	AUDIO-2
PIN4	GND	PIN12	AUDIO-3
PIN5	VIDEO-3	PIN13	AUDIO-4
PIN6	GND	PIN14	NULL
PIN7	VIDEO-4	PIN15	GND
PIN8	GND		

Figure2-21 Definition of Audio and Video Connector's Pins

Fout! Gebruik het tabblad Start om 标题 1 toe te passen op de tekst die u hier wilt weergeven. Fout!  
Gebruik het tabblad Start om 标题 1 toe te passen op de tekst die u hier wilt weergeven.

**NOTICE**

Our TD4104 cards have two different ports; please refer to your user manual according to the product you purchase.

When there are some TD4104 card connects together, please connect the line as following figure.

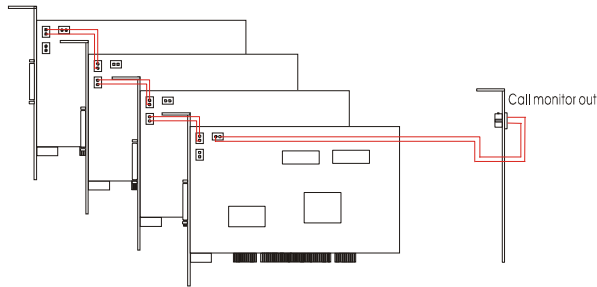

Figure2-22Multi-Card Connection

**2.1.12 TD4116 Card Hardware**

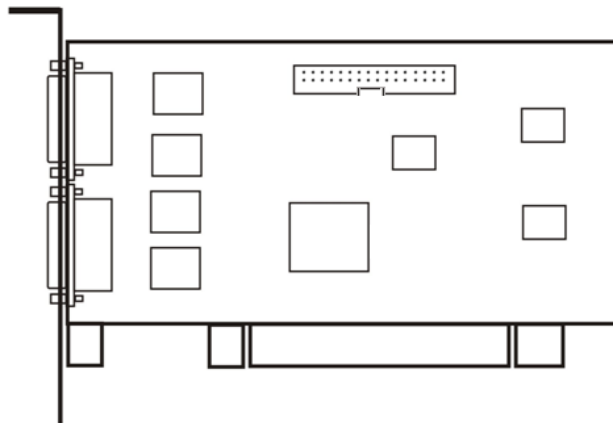
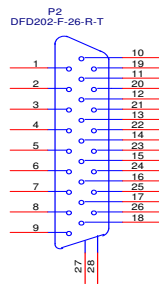

Figure2-23TD4116 Video Capture Card





PIN1	AUDIO2	PIN11	AUDIO3
PIN2	AUDIO4	PIN12	AUDIO5
PIN3	AUDIO6	PIN13	AUDIO7
PIN4	AUDIO8	PIN14	AUDIO9
PIN5	AUDIO10	PIN15	AUDIO11
PIN6	AUDIO12	PIN16	AUDIO13
PIN7	AUDIO14	PIN17	GND
PIN8	AUDIO15		
PIN9	AUDIO16	/	
PIN10	AUDIO1	PIN26	

Figure2-24 Audio Connector and Pins Definition

J1  
GiL-G-8P-S3T2-E

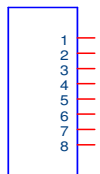

PIN1	VIN-1	PIN2	GND
PIN3	VIN-2	PIN4	GND
PIN5	VIN-3	PIN6	GND
PIN7	VIN-4	PIN8	GND

J2  
GiL-G-8P-S3T2-E

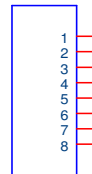

PIN1	VIN-5	PIN2	GND
PIN3	VIN-6	PIN4	GND
PIN5	VIN-7	PIN6	GND
PIN7	VIN-8	PIN8	GND

Figure2-25 Video Pins Definition

### 2.1.13 TD4316/4416L Card Hardware

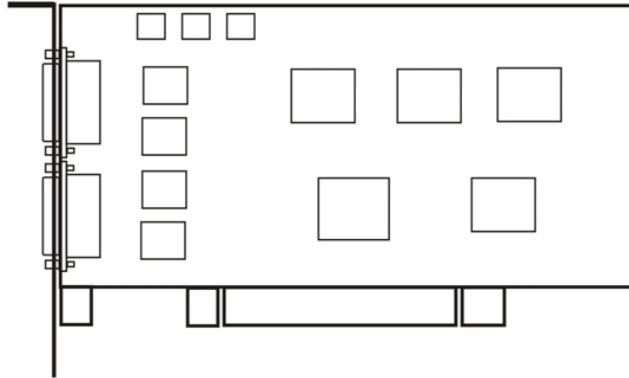
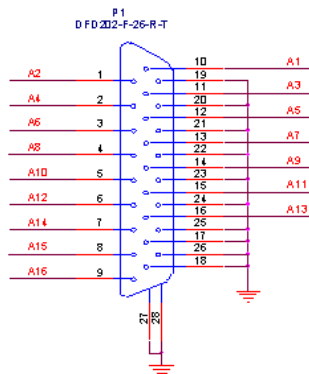

Figure2-26TD4316/4416L Video Capture Card



PIN1	AUDIO2	PIN11	AUDIO3
PIN2	AUDIO4	PIN12	AUDIO5
PIN3	AUDIO6	PIN13	AUDIO7
PIN4	AUDIO8	PIN14	AUDIO9
PIN5	AUDIO10	PIN15	AUDIO11
PIN6	AUDIO12	PIN16	AUDIO13
PIN7	AUDIO14	PIN17	
PIN8	AUDIO15	PIN18	
PIN9	AUDIO16		
PIN10	AUDIO1	PIN19-26	GND

Figure2-27Definition of Audio Connector and Pins

### 2.1.14 TD4108/4308/4408/4408L Card Hardware

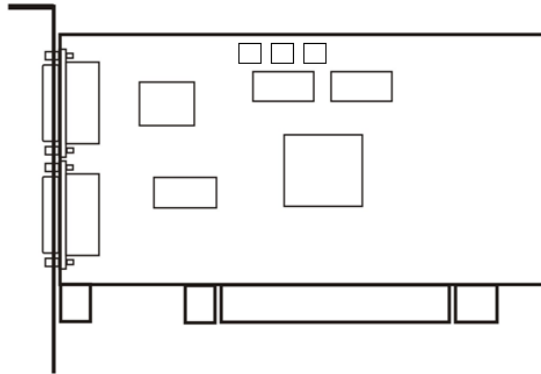
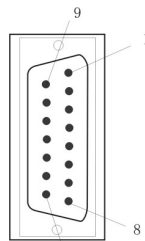

Figure2-28 TD4108/4308/4408/4408L Video Capture Card



PIN1	VIDEO-1	PIN9	GND
PIN2	GND	PIN10	AUDIO-1
PIN3	VIDEO-2	PIN11	AUDIO-2
PIN4	GND	PIN12	AUDIO-3
PIN5	VIDEO-3	PIN13	AUDIO-4
PIN6	GND	PIN14	NULL
PIN7	VIDEO-4	PIN15	GND
PIN8	GND		

Figure2-29 Definition of Audio and Video Connector's Pins

When there are some TD4108 cards connect together, please connect the line as following figure.

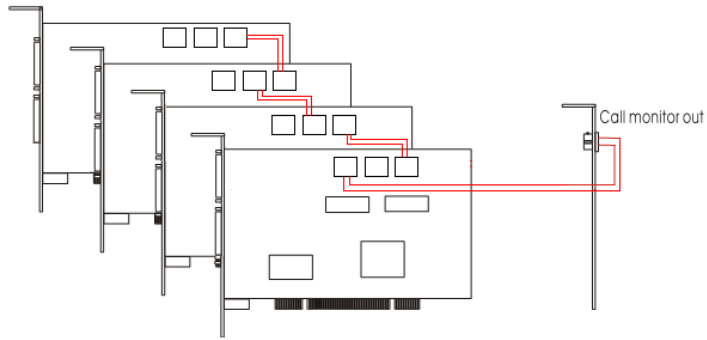

Figure2-30Multi-Card Connection

### 2.1.15 Alarm Board Hardware

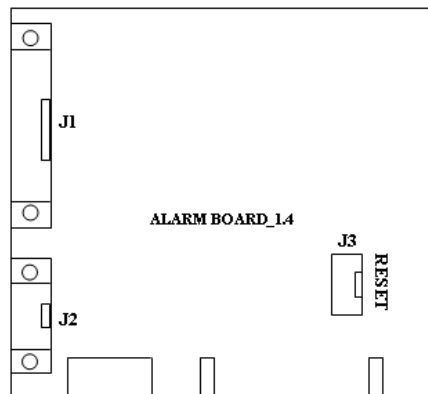

Figure2-31 Alarm Board



PIN1	AI0	PIN6	AI5	PIN11	AI10	PIN16	AI15	PIN21	ALAM_COM
PIN2	AI1	PIN7	AI6	PIN12	AI11	PIN17	A0	PIN22	ALAM_NO
PIN3	AI2	PIN8	AI7	PIN13	AI12	PIN18	A1	PIN23	ALAM_NC
PIN4	AI3	PIN9	AI8	PIN14	AI13	PIN19	A2	PIN24	GND
PIN5	AI4	PIN10	AI9	PIN15	AI14	PIN20	A3	PIN25	VCC

Figure2-32Pins Definition of Alarm Board

Connect J2 to PC serial port and you may use alarm board by SuperDVR system.

### 2.1.16 Connect Audio Signal

For TD3004/3008/3016/3304/3116/3216/4104/4108/4408, connect the audio input device to the microphone connector on the motherboard.

Before installing the Video Capture Card hardware in PCI port of the motherboard, make sure you've installed Microsoft DirectX 9.0. Then turn on the computer, the system will remind you to 'Found new hardware'.

#### NOTICE

Just click '**Cancel**' and ignore the pop-up message.

Insert the CD that contains TD series capture card driver into the CD tray, and run Setup.exe program to install the driver. The default installation path is 'C:\Program Files\SuperDVR'.

#### NOTICE

In case it warns that 'Can't find card' when running the SuperDVR software, please restart the computer.

## 2.2 Install Video Capture Card Driver

**STEP1:** Run Setup.exe, and the installation interface appears as below:

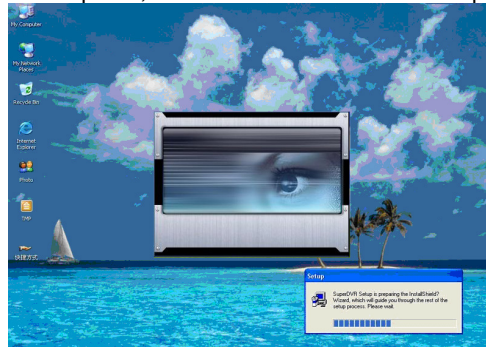

Figure2-33TD Series Video Capture Card Installation Interface

Fout! Gebruik het tabblad Start om 标题 1 toe te passen op de tekst die u hier wilt weergeven. Fout!  
Gebruik het tabblad Start om 标题 1 toe te passen op de tekst die u hier wilt weergeven.

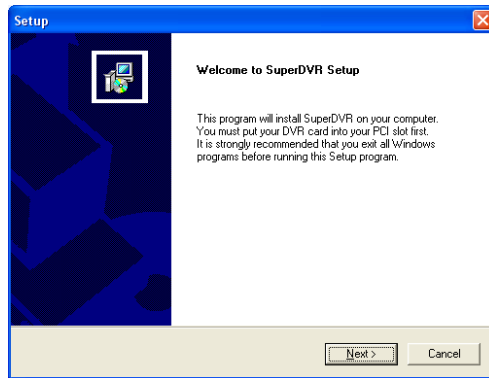

Figure2-34 Welcome Page

**STEP2:** Select video system, click "next"

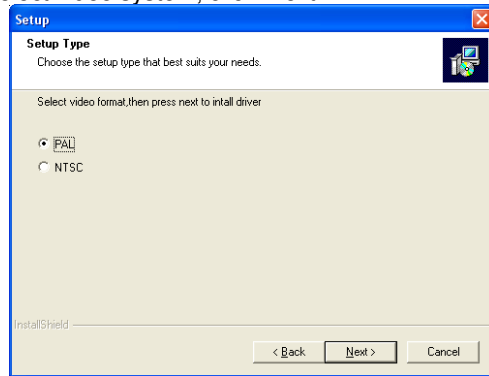

Figure2-35 Select Video Format

**STEP3:** Install driver first.

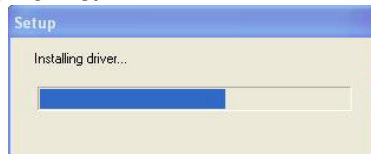

Figure2-36 Rate of Progress of Driver Installation

**STEP4:** After this process, it begins to install the application package SuperDVR, as below:

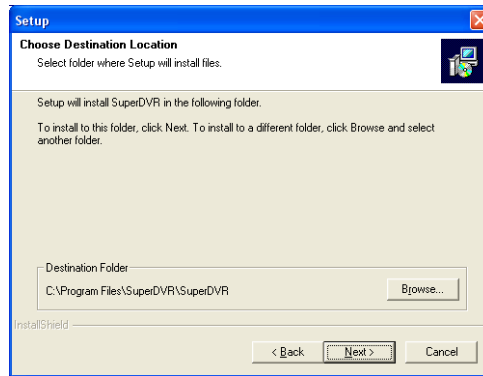

Figure2-37 Select Installation Folder

**STEP5:** Select the suitable option, and click 'Next'.

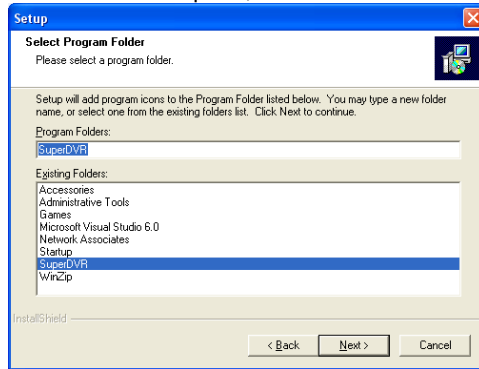

Figure2-38 Register Application

**STEP6:** Click 'Next'.

Fout! Gebruik het tabblad Start om 标题 1 toe te passen op de tekst die u hier wilt weergeven. Fout!  
Gebruik het tabblad Start om 标题 1 toe te passen op de tekst die u hier wilt weergeven.

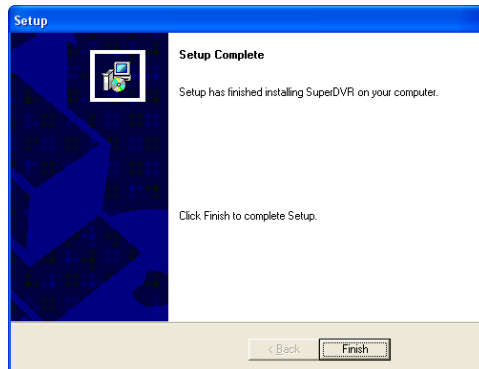

Figure2-39 Driver and Application Installation Finished

**STEP7:** Click 'Finish'.

**STEP8:** Now, after all the processes are finished, it will create a shortcut on the desktop. Restart the computer and launch the surveillance program.



Figure2-40 Shortcut of SuperDVR

**NOTICE**

When you install the driver software on Microsoft VISTA system, you need select the option as below figure first. And steps of install the driver software on Microsoft VISTA system are the same as on Microsoft XP system.

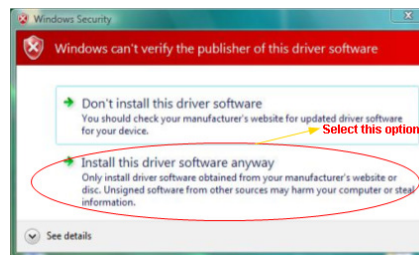

Figure2-41 Install the Software on VISTA

In case users cannot run the SuperDVR program, users restart the computer.



# 3 Main Display Interface

Run SuperDVR program and the main display interface appear as below:

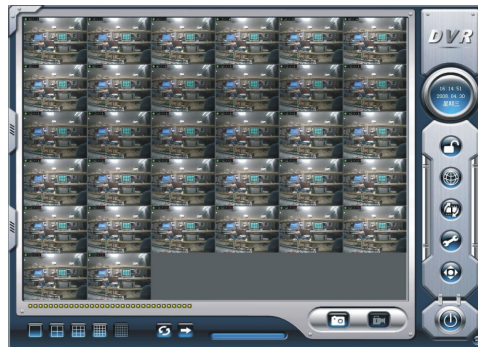

Figure3-1 SuperDVR Main Display Interface

## 3.1 Display Control Panel

### 3.1.1 Display Control Panel



Figure3-2 Display Control Panel

Display control panel includes Display Mode buttons and disk free space indicator, 'Auto Dwell' button. Every button has its built-in indicator light. When switch on and off the buttons, the relative indicator lights turn on and off to indicate the working status.

#### NOTICE

Users can judge which buttons are working by the color of the buttons.

### 3.1.2 Display Modes



Figure3-3 Display Modes Panel

### 3.1.3 Flip Pages

When the display mode is 1CH, 4CH, 9CH, 16CH or 32 CH click , system will display the next page according to the display mode.

### 3.1.4 Auto Dwell Display Mode

In case users want to see all the channels in sequence, then click  and enter Auto Dwell display mode.

### 3.1.5 Capture

In case users want to capture picture quickly, they can click , system will save 32 pictures to the default folder on disk, c:\ path.

### 3.1.6 Urgent Record

Click , system will be recorded and saved all the cameras.

## 3.2 Login

Click , and login window appears. Input the user name and password, the default user name is 'SYSTEM' with no password, users can access to the main interface. Users can change password for SYSTEM and create new user names and passwords once has entered the system.

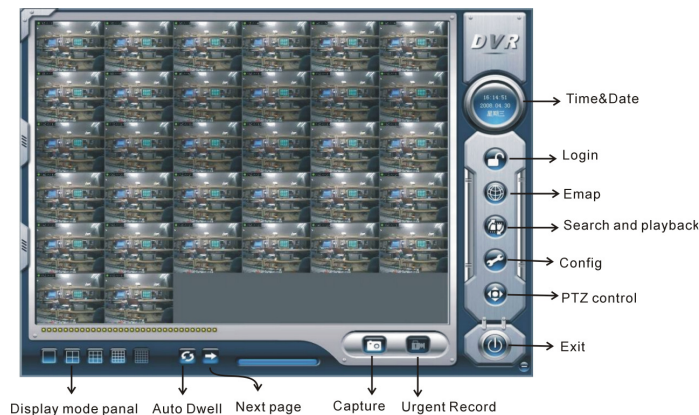

Figure3-4 Main Interface

### 3.3 Record

#### 3.3.1 Record Modes

According to different record triggering methods, video capture cards offer users with 4 kinds of record modes:

- Schedule record mode (timer)
- Manual record mode
- Motion Detection record mode
- Sensor Alarm record mode

Motion Detection record mode and Sensor Alarm record mode are together called as Alarm Record.

In case, users use multiple cameras to record, every camera works separately and the record file also saved separately. The parameters, i.e. camera ID, record date/time, and record mode are all saved together with the record file.

#### 3.3.2 Record Setup

	CAM1	CAM2	CAM3	CAM4	CAM5	CAM6	CAM7	CAM8	CAM9	CAM10	CAM11
Name	CAM1	CAM2	CAM3	CAM4	CAM5	CAM6	CAM7	CAM8	CAM9	CAM10	CAM11
<input type="checkbox"/> Time Stamp	<input type="checkbox"/>	<input checked="" type="checkbox"/>	<input checked="" type="checkbox"/>	<input type="checkbox"/>	<input checked="" type="checkbox"/>	<input checked="" type="checkbox"/>	<input checked="" type="checkbox"/>	<input checked="" type="checkbox"/>	<input checked="" type="checkbox"/>	<input checked="" type="checkbox"/>	<input checked="" type="checkbox"/>
<input type="checkbox"/> Switch	<input type="checkbox"/>	<input checked="" type="checkbox"/>	<input checked="" type="checkbox"/>	<input type="checkbox"/>	<input checked="" type="checkbox"/>	<input checked="" type="checkbox"/>	<input checked="" type="checkbox"/>	<input checked="" type="checkbox"/>	<input checked="" type="checkbox"/>	<input checked="" type="checkbox"/>	<input checked="" type="checkbox"/>
<input type="checkbox"/> Manual Record	<input type="checkbox"/>	<input type="checkbox"/>	<input type="checkbox"/>	<input type="checkbox"/>	<input type="checkbox"/>	<input type="checkbox"/>	<input type="checkbox"/>	<input type="checkbox"/>	<input type="checkbox"/>	<input type="checkbox"/>	<input type="checkbox"/>
Manual Record Frame Rate	5	5	5	5	5	5	5	5	5	5	5
<input type="checkbox"/> Schedule Record	<input type="checkbox"/>	<input type="checkbox"/>	<input type="checkbox"/>	<input type="checkbox"/>	<input type="checkbox"/>	<input type="checkbox"/>	<input type="checkbox"/>	<input type="checkbox"/>	<input type="checkbox"/>	<input type="checkbox"/>	<input type="checkbox"/>
Schedule Record Frame Rate	3	3	3	3	3	3	3	3	3	3	3
<input type="checkbox"/> Motion Detection	<input type="checkbox"/>	<input checked="" type="checkbox"/>	<input checked="" type="checkbox"/>	<input type="checkbox"/>	<input type="checkbox"/>	<input type="checkbox"/>	<input type="checkbox"/>	<input type="checkbox"/>	<input type="checkbox"/>	<input type="checkbox"/>	<input type="checkbox"/>
Motion Record Frame Rate	5	3	5	5	5	5	5	5	5	5	5
Sensor Record Frame Rate	5	5	5	5	5	5	5	5	5	5	5
<input type="checkbox"/> Camera Security	<input type="checkbox"/>	<input type="checkbox"/>	<input type="checkbox"/>	<input type="checkbox"/>	<input type="checkbox"/>	<input type="checkbox"/>	<input type="checkbox"/>	<input type="checkbox"/>	<input type="checkbox"/>	<input type="checkbox"/>	<input type="checkbox"/>
Record Quality	medium	lower	medium	medium	medium	medium	medium	medium	medium	medium	medium
Audio In	None	None	None	None	None	None	None	None	None	None	None

Figure3-5 Record Configuration Panel

In the 'Record Panel' of the Basic Configuration page, users can set all kinds of necessary parameters for recording.

##### 1. Time Stamp

By selecting the options, the record date / time message appears in the record file images.

##### 2. Switch

By selecting the options, users can turn on corresponding cameras. In case there is no camera for some channel, do not select the option so as to save system resource.

##### 3. Manual Record

By selecting the options, the relative camera images will be recorded and saved all the time.

##### 4. Manual Recording Frame Rate

Select the record frame rate for manual record mode.

5. Schedule Record  
Schedule record option
6. Schedule Record Frame Rate  
Select Schedule Record frame rate.
7. Motion Detection  
By selecting the options, users can set relative channels' record mode as motion detection.
8. Motion Record Frame Rate  
Select record frame rate for Motion Detection record mode. Users can set up unified channel parameters in this item.
9. Sensor Record Frame Rate  
If sensors are utilized to trigger recording, users can select record frame rate here.
10. Camera Security  
The users are divided into three standards: Normal user, Power user and Administrator. By selecting the options, only administrators can see the corresponding channels.
11. Record Quality  
Select record image quality here.
12. Audio in  
SuperDVR6.0 system can support one channel of microphone audio input signal on the PC motherboard and audio inputs on the card if it has.. Users can choose one video channel associate these audio signals.

**NOTICE**





Users can select more than one record mode.



### 3.3.3 Record Status Panel



Figure3-6 Record Status Panel & Alarm Output Status Panel

Meanings of indicator light colors in row one is as below:

-  Grey light: Normal State
-  Viridescent light: Manual Record State
-  Bottle-green light: Schedule Record State
-  Yellow light: Motion Detection Record State

-  Red light: Sensor Alarm Record State
-  Blue light: Video Loss State

When the indicator light color turns into red  in row two, it means there is alarm output.

### 3.3.4 Manual Record Mode

Manual Record mode is the most commonly used record mode. In case there is any special event happens, users can select this record mode and record timely.

#### NOTICE

You can select high frame rate for short time manual record, while select low frame rate for long time Schedule Record.

### 3.3.5 Sensor Alarm Record Mode

Users can use sensors to trigger sensor alarm record for relative channels. At that time, the record status indicator light will turn red .

### 3.3.6 Motion Detection Record Mode

It will enable the system to detect image changes and begin to record by activating motion detection and motion alarm record. For instance, somebody opens the door, and the system detects image changes and begins to record, then users can play back the recorded file and find out who opened door. When there is no movement, the system will not record and that is helpful for saving system resource, and convenient for searching for event record file.

The indicator light color in the record status panel is yellow .



#### NOTICE

Users may need to setup in three places to enable motion detection record.

- Select '**Motion Detection**' for certain channels in '**Basic Configuration**'.
- Configure the motion detection areas for certain channels in '**Motion Detection Configuration**'.
- Configure working schedule for certain channels in '**Schedule Configuration**'.

### 3.3.7 Schedule Record

Users can set working schedule for all kinds of record modes in '**Schedule Configuration**'. The bottle-green light  in record status panel shows the corresponding channel is in Schedule Record mode. Users can change

record mode to manual record at any time, and the bottle-green light  will change into viridescent light .

Please refer to '4.4 Configuration' for details.

### 3.3.8 Recycling Record

If users enable Recycling Record function and all the selected HDD partitions are full, the former record data will be covered by the latest record data.

Users can set recording storage sequence for HDD partitions. The recording storage will automatically jump to the next partition when it's full. If all the partitions are full and recycling record mode has been enabled, the new data will overwrite the former recorded data automatically. Users can also set HDD minimum storage alarm. Then once the present storage space is less than the minimum storage and recycling record mode has not been enabled, the record will automatically stop.

# 4 System Setup

Click  and enter the main setup interface.

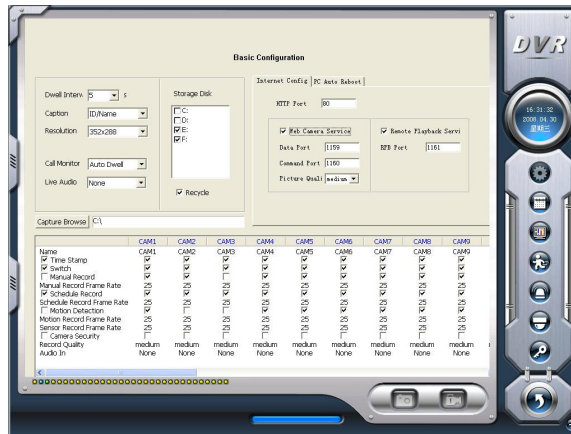

Figure4-1 Basic Configuration

The definitions of the buttons in Figure4-1 are as below:



Basic Configuration

Video configuration

Alarm Configuration

User Configuration



Schedule configuration

Motion Detection Configuration

P.T.Z Configuration

Save and Return

## 4.1 Basic Configuration

Click  and enter the basic configuration page where users can setup the system or just use the defaults.

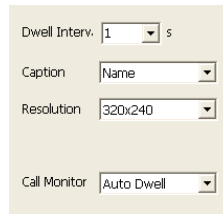

Figure4-2 Caption and General Configuration

1. Dwell Interval.

If users enable Auto Dwell function in the main interface page, users can set the dwell time of a page here.

2. Caption

There are four options, None, ID, Name, and ID/Name for users to select for all the channels.

- **'None'** means no title;
- **'ID'** means camera numbers, i.e. 1, 2, 3 and so on;
- **'Name'** means camera names, i.e. Cam1, Cam2 and so on;
- **'ID/Name'** means both camera number and camera name, i.e. 1/Cam1, 2/Cam2 and so on.

3. Resolution

There are several options: 352×288、352×240 and 704×480、704×576 for users to select for all the channels.

4. Call Monitor

Users can connect another monitor to the card and select the display modes here.

The following is about record data storage. Please check 3.3.8.

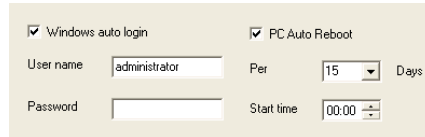

Figure4-3 Record Data Storage Precept

Above, Superdrug system shows all the available HDD partitions for users. Users can select one or more of the partitions that will be used in sequence from up to bottom. Please refer to chapter 3.3.8 to learn more about recycling record.



In the following area in the basic configuration page, users can input the computer user name and password in the relative boxes. Then when restarting the computer system, it will access to the system with the user name and password input in the boxes.



**Figure4-4 Computer System Reboot Setup**

As the windows system may become unstable after a couple of days to continue operating. It may cause SuperDVR system unstable. The software support auto-reboot. Select  **PC Auto Reboot** and set the interval by day, which will guide the system to reboot automatically according to the setups.

#### 5. Capture browse

This item is the save path of capture files

Users can fill in the specific save path for their capture pictures.

Click  to return to the main display interface.

## 4.2 Video Configuration

Click  and enter the video configuration page as below. Users can change the values of corresponding items, i.e. contrast, brightness, hue, saturation, auto gain, by drawing the levers on the bars. Click **'Default'**, and all the values will return to the default value.

Fout! Gebruik het tabblad Start om 标题 1 toe te passen op de tekst die u hier wilt weergeven. Fout!  
Gebruik het tabblad Start om 标题 1 toe te passen op de tekst die u hier wilt weergeven.



Figure4-5 Video Configuration

Definitions of the setup items:

1. Contrast  
Set image color contrast.
2. Brightness  
Set image brightness.
3. Hue  
Set image hue.
4. Saturation  
Set image Saturation
5. Default  
Load defaults, i.e. set the first four items value. The range of value is from 0—255.

### 4.3 Motion Detection Configuration

Click  and enter Motion Detection Configuration page,



Figure4-6 Motion Detection Configuration

Definition of the setup items:

1. Sensitivity

Users can set motion detection sensitivity here.

2. Speed

Motion detection sensitivity

3. Block Number

Set grid's number.

4. Defaults

Set as default.

5. Select All

Select all the areas of the channel as detection area

6. Clear

Clear all the detection areas and then users can select customized detection areas by cursor.

#### 4.3.1 Set Motion Detection Area

In case users want to customize the detection areas for a certain channel, first select the camera, then select '**Clear**' and drag the cursor in the box in the left side. Now, users can see a green box appears which shows the motion detection area. Users can select maximum 16 customized areas for each channel.

#### 4.3.2 Set Motion Detection Area

By click '**Clear**', users can clear all the selected areas.

## 4.4 Schedule Configuration

Click  and enter Schedule Configuration page as below:

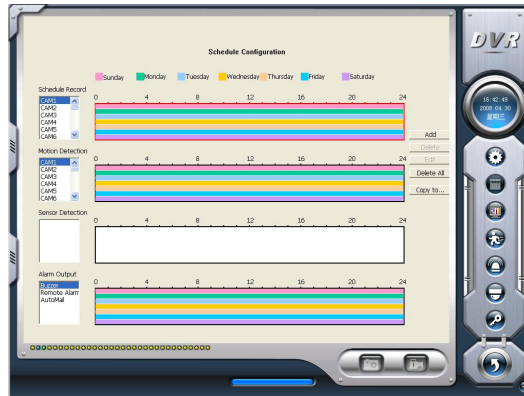

Figure4-7 Schedule Configuration

Our TD series system offers the users with powerful schedule configuration options. Every channel has three kinds of record modes, i.e. schedule record, motion detection record and sensor alarm record. We provide users to set schedules from Sunday to Monday separately for all of the three record modes. Sensor alarm recording mode has the highest priority among all record modes. Here users can set schedules for it.

When users need to edit schedule for a channel, first select the camera name in the three record modes group, and select the color bars on the right side, then select '**Edit**' to edit schedules. Click '**Add**' to add schedule for a certain channel.

**NOTICE**

The added schedule should not be reduplicate to the former settings.

Click '**Delete**' to delete schedule. Click '**Clear All**' to delete all the schedules of a certain channel.

See the Figure 4-8 Edit Schedule and learn how to edit schedules for a channel:

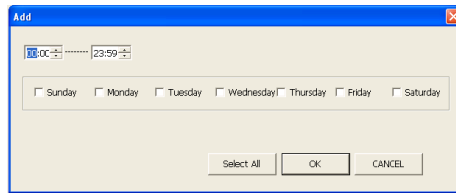

Figure4-8 Edit Schedule

## 4.5 Motion Detection Alarm Configuration

### 4.5.1 Alarm Triggering Conditions Configuration

The system can receive alarm from both local place and network.

#### Local Alarm Record Triggering Configuration

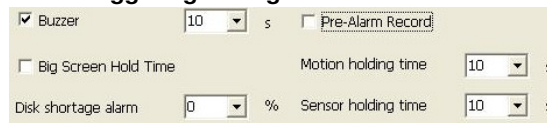

Figure4-9 Local Alarm Triggering Configuration

Relative Explanations:

- Buzzer**  
Users can select whether to open the computer buzzer if the alarms have been triggered and also select how long the buzzer rings
- Pre-Alarm Record**  
Users can select whether to enable alarm pre-record and also pre-record time.
- Big Screen Holding Time**  
The corresponding channel will be full screen when alarm triggered. Set the full screen hold time here.
- Motion Holding Time**  
The continuous recording time after motion stopped
- Sensor Holding Time**  
The continuous recording time after sensor stopped
- Disk Shortage Alarm**  
If the Partition free space is less than the set percent, it will stop recording or recycling, but give alarm tips according to the settings.

Fout! Gebruik het tabblad Start om 标题 1 toe te passen op de tekst die u hier wilt weergeven. Fout!  
 Gebruik het tabblad Start om 标题 1 toe te passen op de tekst die u hier wilt weergeven.

### 4.5.2 Alarm Record

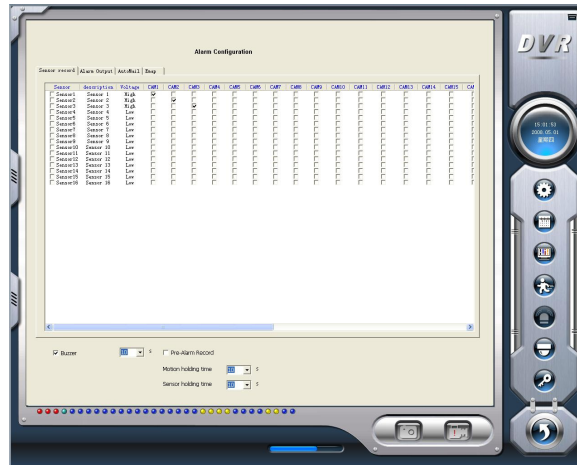

Figure4-10 Alarm Trigger Method Configuration

Every sensor can trigger multiple channels to record. For example, if users select CAM1, CAM4 and CAM5 for Sensor2, then once the sensor is activated, CAM1, CAM4 and CAM5 will begin to record. Users can also select the voltage, high and low, for alarm signals.

### 4.5.3 Alarm Output

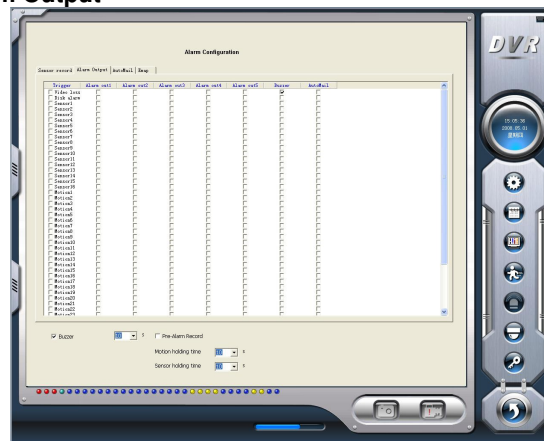



Figure4-11 Alarm Output Configuration

Press  in the main interface and access to the following Alarm

Configuration area where users can make a setup for motion detection alarm, sensor alarm setup and short of HDD space alarm setup.

1. Video Loss

Users can select alarm output for this option. For example, users select alarm\_out1 and alarm\_out3 for video loss. Then video loss of any channel will trigger alarm\_out1, alarm\_out3 to show red light in the Alarm output status panel (refer to Figure3-6 for reference).

2. Disk Alarm

When HDD available space is less than the set value (see Figure4-9), it will trigger alarm.

3. Sensor

Sensor 1: If users have mounted sensors, when the sensors have been activated, then it will trigger the selected output alarms.

Sensor 2 - Sensor 16: TwoTD4116 cards have maximum 16 sensors.

4. Motion

Motion 1: Users can set the output of motion detection alarm by different alarms and remote alarm.

Motion 2 - Motion 16: 32CH card has maximum 16 motion alarms.

**NOTICE**

You should choose our additional alarm device board while using twoTD4116 cards for alarm I/O.

#### 4.5.4 Auto Mail Function

Now users can select the above-mentioned alarms to be output by Auto Mail.

Click '**Auto Mail**' icon on the left top side of alarm configuration page and enter the following area to make Auto Mail setup, referred Figure4-12.

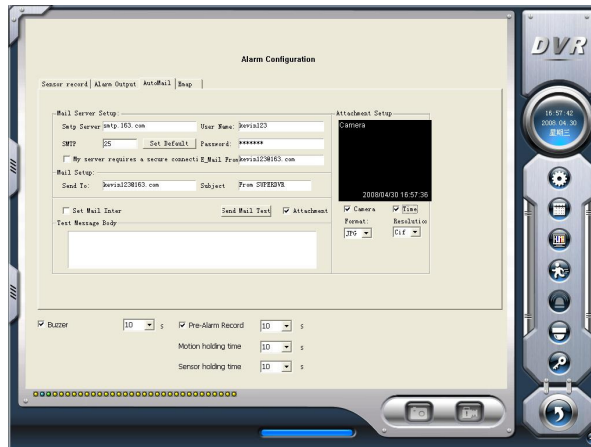

Figure4-12 Auto Mail Setup Interface

In this area, users can set receiver and sender's E-mail SMTP server and address. Note: the address of receiver and sender can be the same.

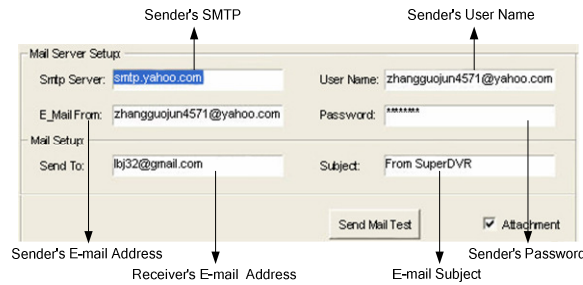

Figure4-13 Auto Mail Setup

To test the settings, click '**Send Mail Test**'. If all settings are okay, message 'Message Sent Successfully' will pop up. If some settings are wrong, there will pop up corresponding warning message.

Enable '**Attachment**', then the present image when an alarm triggered will be sent to appointed mailbox, referred Figure4-14.



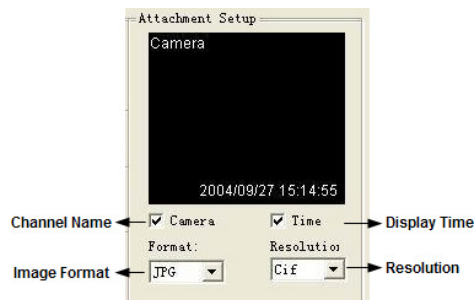

Figure4-14 Attachment Setup

**NOTICE**  
For every alarm event, only one picture will be sent.

## 4.6 E-map Configuration

E-map is used to show full geographic range covered by the whole monitoring system in the form of map .An E-map has the feature of simple operation and direct display of status and it is generally graded or tiered in the form of a tree diagram.

### 4.6.1 Edit Map

It supports only the image format of bmp or jpg.



Click  to enter 'Emap → Emap Edit', press right key of Load Picture in the default interface of map and select the required map file in the related folder, open the file and the map will be displayed in this interface, as Figure4-15 E-Map Edit.

Fout! Gebruik het tabblad Start om 标题 1 toe te passen op de tekst die u hier wilt weergeven. Fout!  
Gebruik het tabblad Start om 标题 1 toe te passen op de tekst die u hier wilt weergeven.

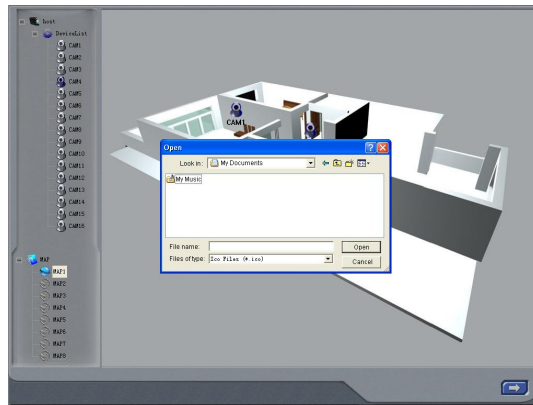



Figure4-15E-Map Edit

Draw the icon of camera to the corresponding position in the map, maximum 32 cameras can be set simultaneously. Click 'change icon' of camera by right key to change icon and click **Delete** to cancel camera. After editing, click right key in the map and select **Save Map** to save the current map.

A gray map icon can be drawn to the corresponding position in the map on the right and set it as a sub-map of the current map, or click the gray map icon on the left by right key and select **Open** to build a new map. And you can also click the blue map icon on the left by right key, and select **Rename** to change name of the map or select **Close** to cancel this map.

#### 4.6.2 View Map

Click  to enter E-map, where the user can view distribution of all cameras in the map, as Figure4-16 View Camera.

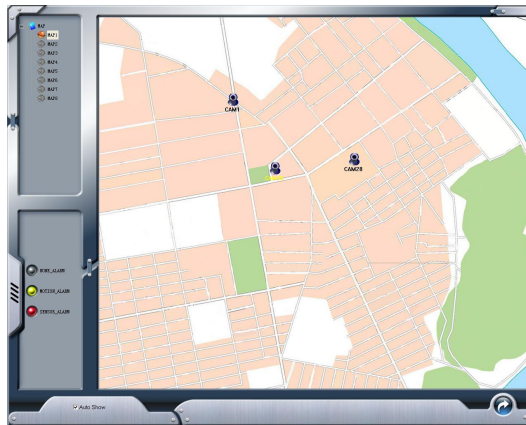



Figure4-16 View Camera

When a channel alarm, the camera icon will flash yellow alarm signal. Select 'Auto Show', in case of accident alarming, an alarming screen will pop out automatically and you can know about the alarming position rapidly. Click the camera head by right key to show the screen on the spot.

**NOTICE**

1. The map tree currently supports three levels and it is invalid for addition exceeding three levels.
2. For loading of a picture, when any side of length and width of the picture exceeds size of picture frame, it will be enlarged and shortened proportionally and standard size of picture frame is 833\*678.
3. On this interface, click camera by right key to display the spot and the 3316 card does not support this function temporarily.
4. If 'Auto Show' is set in case that E-map pops up by automatic alarming, the E-map interface set with 'Holding Time' without any operation and alarm will be close automatically. 'Auto Show' is invalid when the E-map is opened manually.
5. The map in the E-map is the default demonstration map, and the user can invite an engineering merchant to make the practical map or draw a map by their own according to their actual needs, then scan and save it in the computer to picture.

## 4.7 P.T.Z Control Configuration

Click  and enter the following area:

Fout! Gebruik het tabblad Start om 标题 1 toe te passen op de tekst die u hier wilt weergeven. Fout!  
 Gebruik het tabblad Start om 标题 1 toe te passen op de tekst die u hier wilt weergeven.

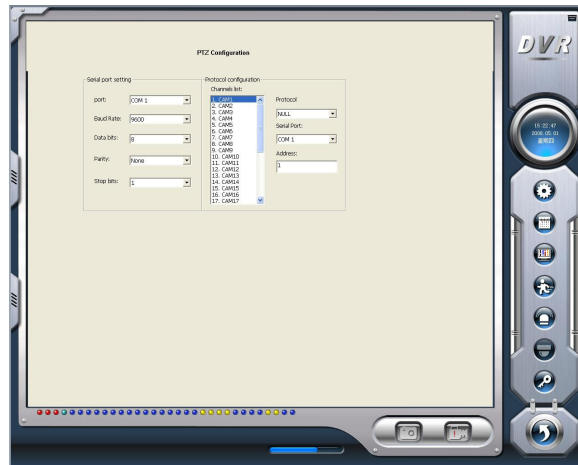

Figure4-17 PTZ Configuration Panel

#### 4.7.1 Protocol Setup

Users can select different protocols, serial port number for P.T.Z devices.

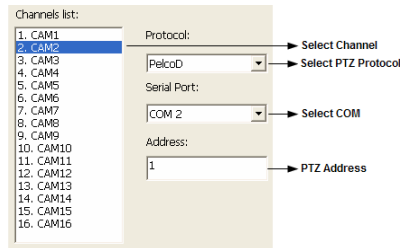
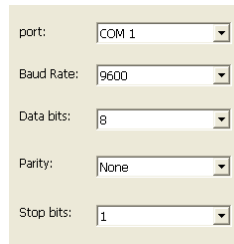

Figure4-18 P.T.Z Protocol Setup

1. Port  
Users can set serial port number.
2. Protocol  
Communication protocol of P.T.Z device
3. Address  
Communication address of P.T.Z device

#### 4.7.2 Serial Ports Setup

Users should firstly enable the P.T.Z control function of a certain camera and select a port number in P.T.Z Protocol Setup (refer to Figure4-18), and then set corresponding parameters in the area below:



port:	COM 1
Baud Rate:	9600
Data bits:	8
Parity:	None
Stop bits:	1

Figure4-19P.T.Z Serial Port Setup

1. Port  
Users can set port number.
2. Baud Rate  
Set P.T.Z device Baud Rate, default value is 9600.
3. Data Bits  
Default value is 8.
4. Parity  
Odd and even parity bit, default Null.
5. Stop Bits  
Default value is 1.

**NOTICE**

Users should look into the P.T.Z device and get the Baud Rate, Protocol, and Address first, then set their values accordingly.

## 4.8 Users Configuration

Click  and access the following area:

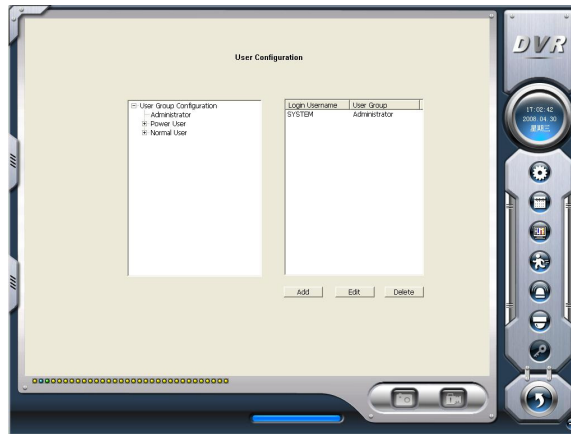

Figure4-20 User configuration

After installing the SuperDVR system, it will automatically create an administrator user of which user name is SYSTEM with no password. Users can use this username to log in the system and 'Add', 'Edit' or 'Delete' users' parameters.

#### 4.8.1 Change User rights

Select a user in User Configuration area (refer to Figure4-20), and click 'Edit' and enter Edit User area, as below:

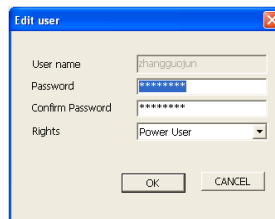
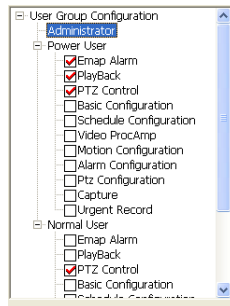

Figure4-21 User Password and Rights Edit

Users can edit user's password and rights here, but not the user name.

The system offers three kinds of rights:

- Administrator: this user possessed the highest rights to change all the settings and playing back. Meanwhile, the user also has the right to authorize power user rights and normal user rights.
- Power user: The right of this kind of users is authorized by the administrator. The administrator endows rights to power users by ticking off boxes in the right list. Please refer to the following figure.



Normal User: Normal user's right is also endowed by the administrator. They have the same right list as power user. However, whether they can possess some right should be decided by the administrator. Only if the administrator ticks off some right, they will have the right. For example, if ticking off *Basic Configuration*, the normal user can conduct this right.

**NOTICE**

Administrators can change and authorize rights to Power users and Normal users, but they cannot change or authorize other administrators' rights.

**4.8.2 Add User**

Click 'Add' in User Configuration (refer to Figure4-20), and access the following area:

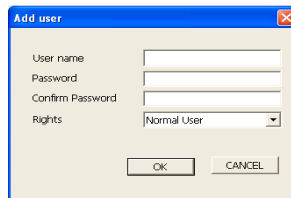

Figure4-22Add User

Input user name, password, confirm password and select user rights, and then click 'OK'.

**4.8.3 Delete User**

Select the user name in User Configuration (refer to Figure4-20), and click 'Delete', and confirm delete. See below:

Fout! Gebruik het tabblad Start om 标题 1 toe te passen op de tekst die u hier wilt weergeven. Fout!  
Gebruik het tabblad Start om 标题 1 toe te passen op de tekst die u hier wilt weergeven.

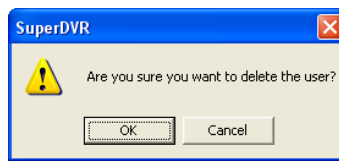



Figure4-23 Confirm Delete User



# 5 P.T.Z Control

Click  in the SuperDVR main display interface (refer to Figure3-1) and access to the following area:

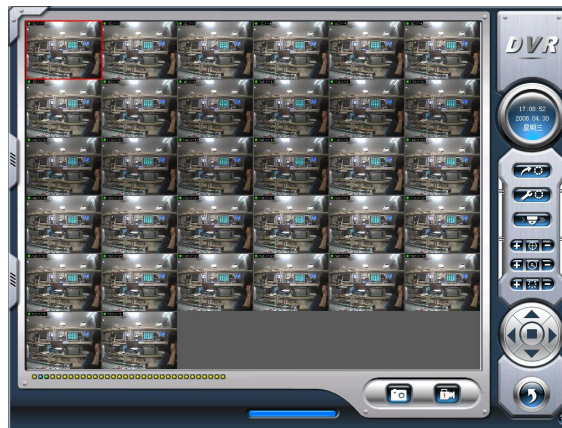

Figure5-1 P.T.Z Control Interface

Users can control P.T.Z devices by the function buttons on the right side, see as below:

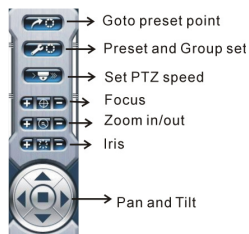

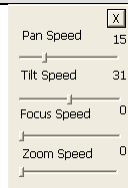

Figure5-2 P.T.Z Control Function Buttons Panel

In the upper circle, there are five function buttons, i.e. upward button, downward button, leftward button, rightward button, and stop button. The other buttons are Focus buttons (+ and -), Zoom buttons (+ and -), Iris buttons (+ and -). Click  and  to increase and decrease the corresponding values.

When users need to utilize P.T.Z control, first enter P.T.Z Control Interface (refer to Figure5-1), and click the corresponding channel (users can see a red fringe around the channel), then users can begin to control the enabled P.T.Z control enabled camera.

**NOTICE**  
After pressing left mouse button on any function button in P.T.Z Control Function Buttons Panel (refer to Figure5-2), PTZ device starts moving, when user releases it, PTZ device stops moving.



**Figure5-3 Speed Adjustment**

Users can select different Pan speed, Tilt speed, Focus speed and Zoom speed for P.T.Z devices.

1. Pan Speed  
Set horizontal rotating speed.
2. Tilt Speed  
Set vertical rotating speed.
3. Focus Speed  
Set camera focus speed.
4. Zoom Speed  
Set zoom in/ zoom out speed.



Click  and a pop-up window will appear; users can choose different preset or group set.



Figure5-4 Preset and Group Select

Click  to set Preset point and change Preset point name. Every Group includes multiple Preset points. In case users select preset1, preset2 and preset3 for group1, preset1, preset2 and preset3 will be automatically accessed in sequence after users select group1 for auto scout.

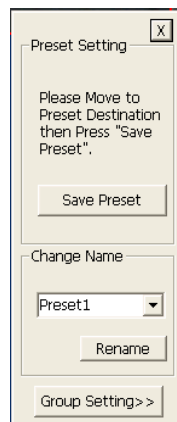



Figure5-5 Preset

Click , a pop-pup window as following will appear:  
Dwell: users can set the dwell time of a preset here.

Fout! Gebruik het tabblad Start om 标题 1 toe te passen op de tekst die u hier wilt weergeven. Fout!  
Gebruik het tabblad Start om 标题 1 toe te passen op de tekst die u hier wilt weergeven.

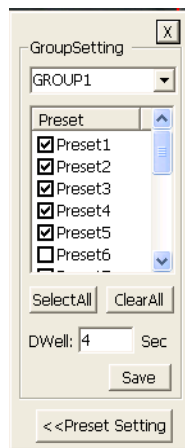



Figure5-6 Group Configuration

# 6

## Record Search & Playing Back

Click  in the SuperDVR Main Display Interface (refer to Figure3-1) and access to the following areas:

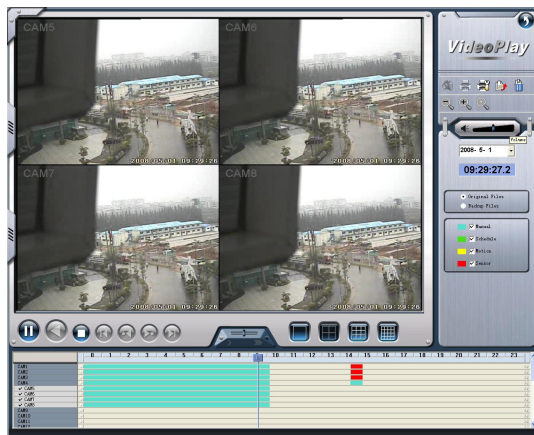



Figure6-1 Search and Playback Interface

This interface is divided into 4 parts, i.e. record search area, record playing back area, record play area, and other functions area.

Press  and return to the live surveillance status.

## 6.1 Record Search

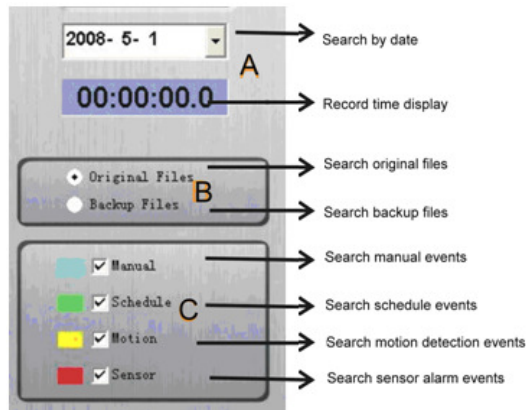

Figure6-2 Record Search Area

A, B and C marks the areas of three search methods.

- **A:** Search by date (range from Jan 1<sup>st</sup>, 1971 till now)
- **B:** Search in backup file and original file
- **C:** Search by record mode. This is useful when user wants to look through some important events.

Users can select one or above of the three searching methods to search for needed record file.

## 6.2 Playing Back and Control

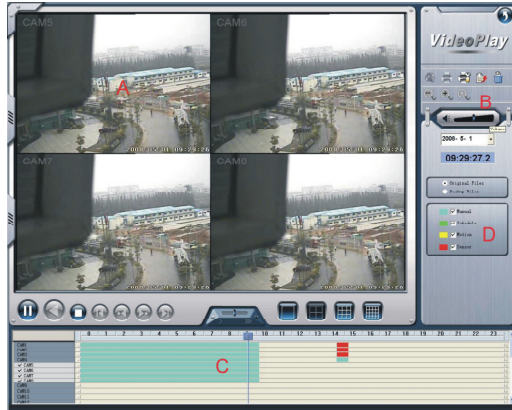









Figure6-3 Playing Back and Control

Explain of the button function:

-  : Play / Pause
-  : Stop
-  : Play backwards. This button is valid when playing back by single channel
-  : Previous Section. This button is valid when playing back by single channel
-  : Next Section. This button is valid when playing back by single channel
-  : Previous Frame. This button is valid when playing back by single channel playing back pause mode
-  : Next Frame. This button is valid when playing back by single channel playing back pause mode

Users can select suitable play speed in the area as below:



Figure6-4 Play Speed Controller

The following area shows the record files of different channels:

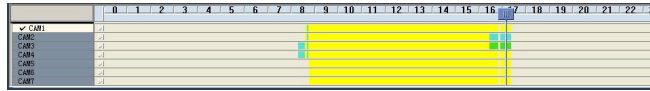

Figure6-5 Record Files Browser

The upper bar shows the hours in a whole day. Click the bar, and it will be magnified 10 times, therefore users can see the detailed time marks. When searching for a certain section of the file, users can draw the scrolling-bar to the area that most likely contains the needed section. If necessary, click the bar once and see the magnified time marks for precise search.

The left side shows the available channels. When a certain channel has been selected for playing back, the background color will be highlighted, or its dark gray, and a tick sign will appear beside the channel title.

The main area at the center gives details of the record files. Different colors of the bar show different kinds of record modes of the files. The following are the definitions of the color bars:

- Blue: Manual Record Events
- Green: Schedule Record Events
- Yellow: Motion Detection Record Events
- Red: Sensor Alarm Record Events



Click  to play selected record files. The system offers playing back modes 1 Ch, 4CH, 9 CH, and 16CH. The following is multiple channels playing back control area:



Figure6-6 Multiple Channels Playing Back Control

The system default playing back mode is one channel. That is Camera1. In

case users need to change to other channels, then click  and the window of following channel configuration will appear, as below:



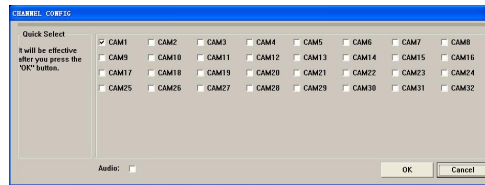



Figure6-7 Channel Configuration Dialog for Single Channel Playing Back Mode

Users can select one channel from all the available channels for playing back.

In case user needs to play back 4 channels at the same time, then click ,

and the following channel configuration window will appear, as below:

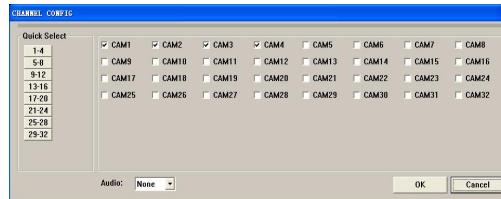



Figure6-8 Channel Configuration Dialog for 4-channel Playing Back Mode

Users can select any four channels from all the available channels for playing back.

The system offers quick select methods for users. For example, by selecting 'Third 4 Channels', Camera9, Camera10, Camera11, and Camera12 will be quickly selected simultaneously.

In case user need to playback 9 channels at the same time, then click ,

and the following channel configuration window will appear, as below:

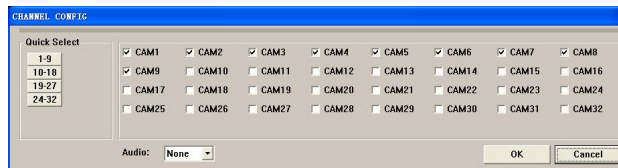



Figure6-9 Channel Configuration Dialog for 9-channel Playing Back Mode

Users can select any 9 channels from all the available channels for playing back. Users can also use the quick select methods by the system.

In case user needs to play back 16 channels at the same time, then

click , and the following channel configuration window will appear, as below:

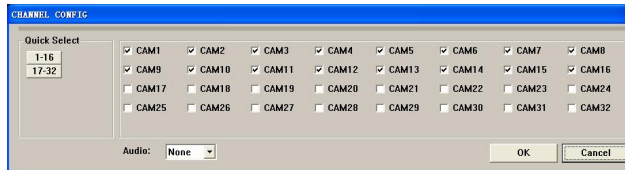



Figure6-10 Channel Configuration Dialog for 16-channel Playing Back Mode

Then click 'OK' to play back.

**TIPS**  
Click any channel and magnify it to see the single channel. Click again to return to the former playing back mode.

## 6.3 Other Functions

### 6.3.1 Record File Backup

Click  and enter the following menu:

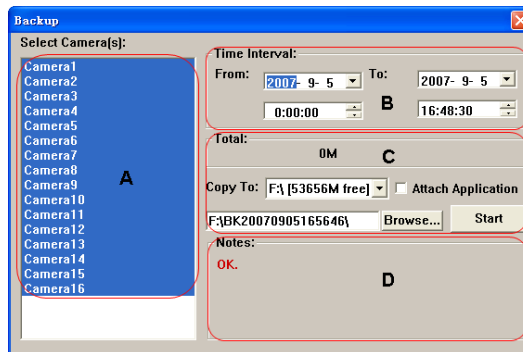

Figure6-11 Recorded Files Backup

Users can select corresponding cameras and copy the record files to another path in this area. This is the file backup function of the system.

The interface is divided into four areas:

- **A:** Camera Selection Area
- **B:** Time and Date Selection Area
- **C:** Operation Area

- **D: Information Area**

In A area, users can select one or more cameras.

In B area, users can set start time/date and end time/date, and then backup the files recorded by channels selected in an area by the time interval.

In C area, users can set backup path.

Click '**Start**' to backup files.

### 6.3.2 Delete Record Files

Click  and the following window will appear:

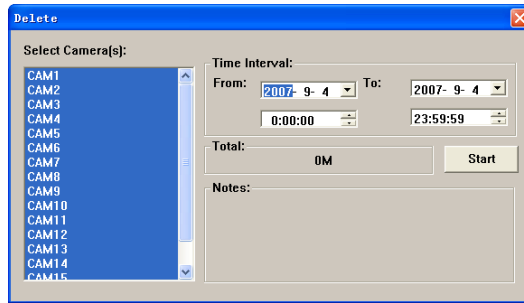

Figure6-12Delete Recorded Files

Users first select the channel on the left side, and then select start time/date and end time/date of the record files, click '**Start**' to delete files.

### 6.3.3 Capture Pictures

The definitions of the function buttons are as below:



: Capture picture



: Print setup



: Print captured picture

#### NOTICE

This  function is valid only in playback pause mode of single channel.

When in single channel playing back pause mode, automatically the following color control panel (Figure6-13) will appear, by which user can make color rectification for the present channel, including brightness, contrast, saturation and hue, and press '**Default**' to recover to the original settings.

Fout! Gebruik het tabblad Start om 标题 1 toe te passen op de tekst die u hier wilt weergeven. Fout!  
 Gebruik het tabblad Start om 标题 1 toe te passen op de tekst die u hier wilt weergeven.

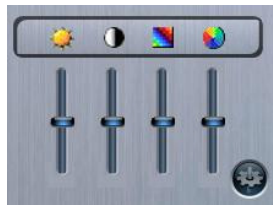



Figure6-13Color Control Panel

When in the single channel playing back pause mode, click  and the following window will appear as below:

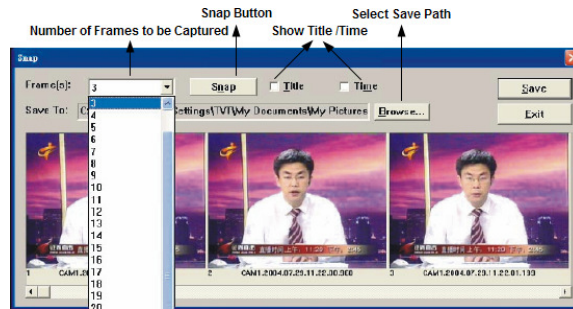

Figure6-14Capture Multiple Images in Sequence

Select path and click 'Save' to save the picture. User can also print the images that have been captured.

Click  and make corresponding print setup as below:

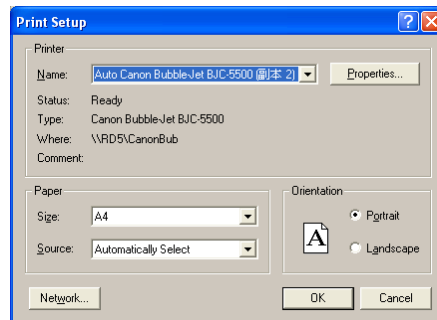



Figure6-15Print Setup

Click  users can have print preview as below:

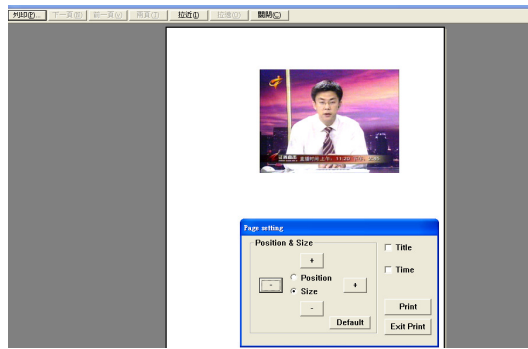





Figure6-16Print Preview

Select  **Position** and then click  or  to move the picture upward, downward, leftward and rightward. Select  **Size** and then click  and  to zoom in and out the image. Press  return to the original settings. Press **Print** in the print preview window, users can print the image directly.

#### 6.3.4 Image Zoom in/out

When in single channel playing back state, the zoom control icons  will appear. Select  and click on the channel will zoom out the image. By clicking continuously, the image will be zoomed out continuously. Select  and do the some operations to get the opposite effect. Click  and recover the original size. Take the following three pictures for example.

Fout! Gebruik het tabblad Start om 标题 1 toe te passen op de tekst die u hier wilt weergeven. Fout!  
Gebruik het tabblad Start om 标题 1 toe te passen op de tekst die u hier wilt weergeven.



Figure6-17Example: original size

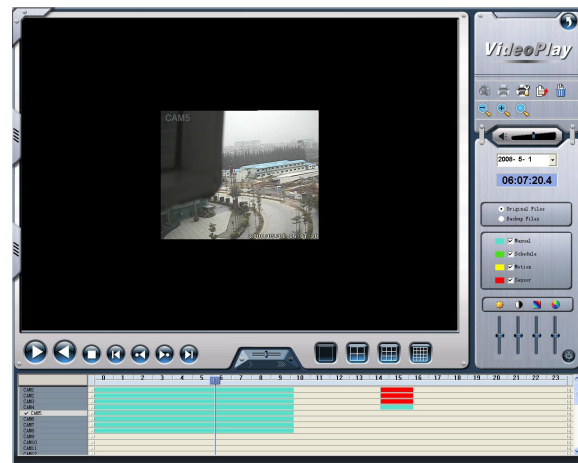

Figure6-18Example: zoomed out



Figure6-19Example: zoomed in

# 7 IE Client

## Remote Live Surveillance

Surveillance system supports Remote Surveillance through LAN, Internet, and Intranet. Simply enable web cam function of the system on a computer which is connected to Internet, and the computer system will become an Internet web cam server. On any other computer that connects to Internet or the same LAN network, input the SuperDVR server address in IE browser, the end users can get high quality real time image from the server and also control the P.T.Z devices.

### 7.1 Remote Surveillance Server Configuration

Users should firstly enable the Web Camera Services in Basic Configuration (refer to Figure4-1) and set other settings as below:

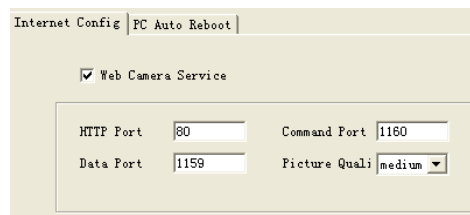

Fig 7.1 WebCam Server Configuration

HTTP Port

Web service & download service port, default value is 80.

Data Port

Data transmission port, default value is 1159.

Command Port

Control command port, default value is 1160.X



Picture Quality  
Default value is medium.

## 7.2 Accessing IE client

If users want to remote view pictures, the IE client should be connected to LAN or Internet. And then enable network server in the unit. Please refer to Fig7.1 IE client Server Configuration. This unit supports IE browser, not any client software installed. And it supports Win XP and vista.

Input the IE client server IP address in Internet Explorer and selected install ActiveX control, then the following figure appears:

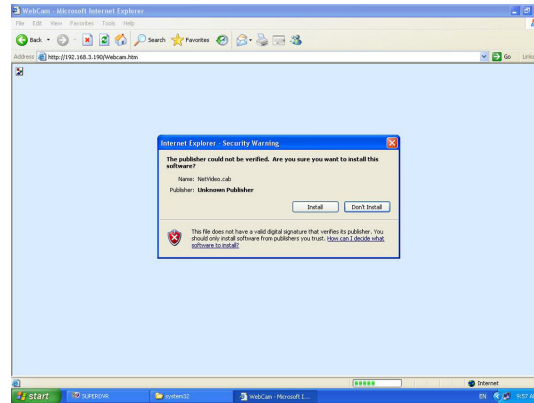

Fig 7.2 WebCam install interface

Click install button, then the WebCam main interface will appear as below:

Fout! Gebruik het tabblad Start om 标题 1 toe te passen op de tekst die u hier wilt weergeven. Fout!  
 Gebruik het tabblad Start om 标题 1 toe te passen op de tekst die u hier wilt weergeven.

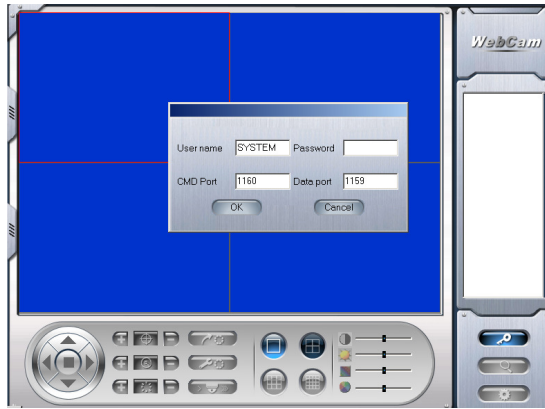

Fig 7.3 WebCam Login interface

















**NOTICE:** The default User name is SYSTEM with no password. Users can set user name and password at the server. Click **OK** and then enter into WebCam Main interface.

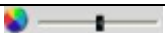

Fig 7.4 WebCam Main interface

Corresponding Explanations:

Icon	Description
------	-------------

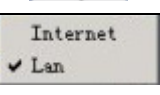
	<p>▲ means the dome rotate up. ▼ means the dome rotate down. ◀ means the dome rotate left. ▶ means the dome rotate right. ■ means the dome stop rotating.</p>
	<p>'Focus' button. Click + button near 'Focus' button to have long focus. Click - button near 'Focus' button</p>
	<p>'Zoom' button. Click + button near 'Zoom' button to zoom in the locale picture of this camera. Click - button near 'Zoom' button to zoom out the locale picture of this camera</p>
	<p>'Iris' button. Click + button near 'Iris' button to increase light of the dome. Click - button near 'Iris' button to decrease light of the dome.</p>
	<p>Go to the presenting Point</p>
	<p>Set the Presetting Point</p>
	<p>Speed dome. Adjust PTZ speed. It sets the rotational speed of the PTZ</p>
	<p>Single channel with full screen display</p>
	<p>Four channel with four pictures display</p>
	<p>Contrast adjustment</p>
	<p>Brightness adjustment</p>
	<p>Hue adjustment</p>
	<p>Saturation adjustment</p>
	<p>Log in/ Log out</p>
	<p>Record playback</p>
	<p>System Configuration</p>
	<p>Enable the Lan that is Master stream, has higher frame rate and needs higher network bandwidth; Internet that is sub stream, has low frame rate and</p>

Fout! Gebruik het tabblad Start om 标题 1 toe te passen op de tekst die u hier wilt weergeven. Fout!  
 Gebruik het tabblad Start om 标题 1 toe te passen op de tekst die u hier wilt weergeven.

requires low net work bandwidth. Users can select the stream according to their bandwidth.

**Table 7-1 the function of the main interface buttons**

Click the right mouse in the main interface a sub menu will appear:

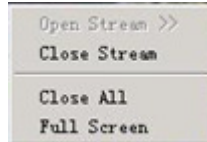

Open Stream: Click this item, selected channel will open

Close Stream: Click this item, selected channel will close

Close All: Click this item, all channels will close

Full Screen: Select this item, the picture will display in full screen. Double click or click right mouse to return to the previous interface.

### 7.3 Remote playing back

#### 7.3.1 Record play back and control

Click  button on the Webcam main interface, the remote play back picture will appear:



**Fig 7.5 Remote play back**

Explain of the button functions:

 : Play/ Pause



: Stop



: Adjust the speed of playing back. Users can select suitable play speed in needed.



: Playing back backup. Back up record data of server-end.

Users can click Backup, enter into the below interface:

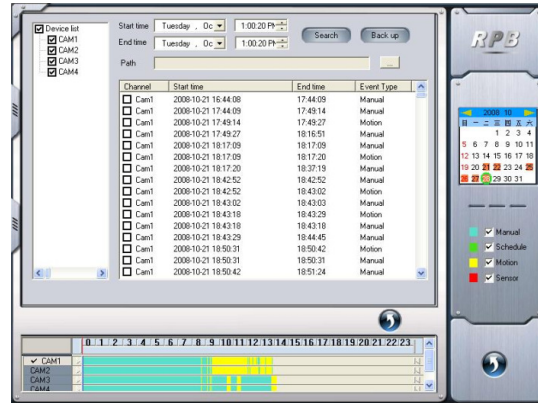

Fig 7.6 Remote backup

**STEP1:** Select the date, channel, then click Search button. It will list all files recorded in the day.

**STEP2:** Click Browse button, set the saving path.

**STEP3:** Select files in the search area. Users can hold shift button of keyboard and select multi files with mouse simultaneously.

**STEP4:** Click Backup button to do remote backup.

**Notice: the backup files are AVI format. Users can play with the third player directly.**

Click the right mouse in the search area, a sub menu will appear:

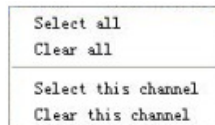

If users select all channels, click Select all, then all check box before channels will be selected. Users can click Clear all to clear all selected channels; if

users select a certain channel, click Select this channel, then just this channel be selected only. Users can click Clear this channel to clear that selected channels.



: Return to previous main interface



: Multiple Channels playing back control

The system default playing back mode are single and four channel. In case users need to change to other channels, then click button, the following channel configuration window will appear:

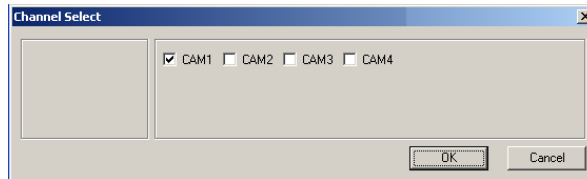

**Fig 7.7 Channel configuration window for 1 channel play back mode**

Users can select one channel from all the available channels for playing back.

Click , users can play back in four channels mode. Four channels configuration window will as show as below:

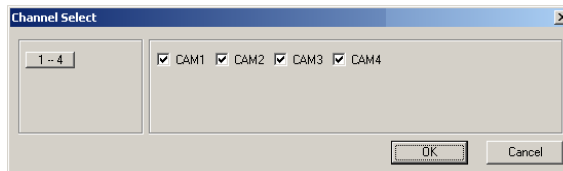

**Fig7.8 Channel configuration window for 4 channel playback mode**

Users can select any four channels from all the available channels for playing back.

The following area shows the record files of different channels:

	0	1	2	3	4	5	6	7	8	9	10	11	12	13	14	15	16	17	18	19	20	21	22	23	
✓ CAM1																									
CAM2																									
CAM3																									
CAM4																									

**Fig 7.9 Data Preview**

Data preview shows the record data for different channels in corresponding

time, the left side shows the available channels. When a certain channel has been selected for playing back, the background color will be highlighted, or its dark gray and a tick sign will appear beside the channel title.

The data preview area at the center gives details of the record files. Different colors of the bar show different types of records. The following are the definitions of the color bar:

-   Manual : Manual Record Events
-   Schedule : Schedule Record Events
-   Motion : Motion Detection Record Events
-   Sensor : Sensor Alarm Record Events

The ruler on top of the bar shows the hours in whole day. Right-click the ruler, it will be magnified 10 multiples. Therefore, users can see the time marks in details.

**STEP1** When users want to search for a certain section of record, draw the bar to the desired position. If necessary, right-click the bar to see the magnified time marks for precise search.

**STEP2** Users can click  button to play the selected record, Then return to live display mode after finishing remote playback, it will display a word 'Connecting...' on the screen. And users may click "Large Picture" or "Quad Picture" button to fresh screen to get live picture.

## 7.4 System setup

Click  and enter into the main setup interface.

Fout! Gebruik het tabblad Start om 标题 1 toe te passen op de tekst die u hier wilt weergeven. Fout!  
Gebruik het tabblad Start om 标题 1 toe te passen op de tekst die u hier wilt weergeven.



Fig 7.10 Basic Configuration

**Notice:** When multi-client accessed the system configuration interface simultaneous, the user who enters into that interface priority and then others will lack of accessing rights.

#### 7.4.1 Basic Configuration

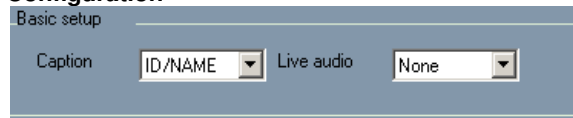

Fig 7.11 Basic setup

##### 1. Caption

There are four options: None, ID, Name and ID/Name for select from.

- 'None' means no title
- 'ID' means camera numbers, i.e.1,2,3 and so on
- 'Name' means camera names,i.e.Cam1, Cam2 and so on
- 'ID/Name' means both camera number and camera name,i.e.1/Cam1, 2/Cam2 and so on

##### 2. Live audio

Supports one channel of microphone audio input signal on the PC motherboard and audio inputs on the card if it has... Users can choose on video channel associate these audio signals.

In the following area in the basic configuration page, users can input the



computer user name and password in the relative boxes. Then when restarting the computer system, it will access to the system with the user name and password input in the boxes.

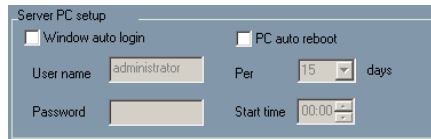
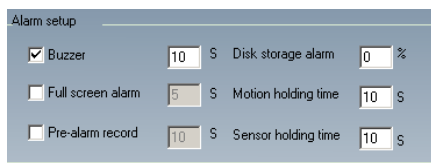

**Fig 7.12 Computer System Reboot Setup**

As the windows system may become unstable after a couple of days to continue operating. It may cause SuperDVR system unstable. The software supports auto-reboot. Select  PC auto reboot and set the interval by day, which will guide the system to reboot automatically according to the setups.

### 3. Alarm setup

The Alarm setup configuration is show as below:



**Fig 7.13 Alarm triggering configuration**

Relative Explanations:

#### 1. Buzzer

Users can select whether to open the computer buzzer if the alarms have been triggered also select how long the buzzer rings

#### 2. Full screen alarm

Users can select whether channel will be full screen when alarm triggered. Set the full screen hold time here

#### 3. Pre-alarm record

Users can select whether to enable alarm pre-record and also pre-record time  
This option is for users to see remote live view.

#### 4. Disk storage alarm

If the Partition free space is less than the set percent, it will stop recording or recycling, but give alarm tips according to the settings

5. Motion holding time

The continuous recording time after motion stopped

6. Sensor holding time

The continuous recording time after sensor stopped

### 7.4.2 Camera setup

Click  and the camera setup configuration will appear as below:

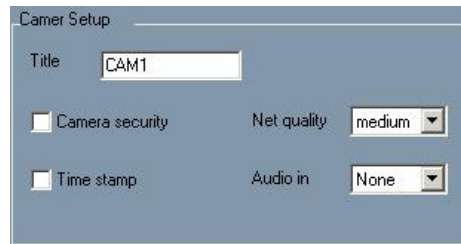

Fig 7.14 Camera setup configuration

1. Title

Channel name. Users can set the channel name from Cam1, Cam2, Cam3 and Cam4.

2. Camera security

Users are divided into two standards: normal user and super admin. By selecting this option, only administrator can see corresponding channels.

3. Time stamp

If selecting the check box, record time will be displayed on the screen when playing back the record

4. Net quality

There are five options to choose from: lowest, lower, medium, higher and highest. Higher picture quality is, the picture is clearer.

5. Audio in

If users select the check box, Webcam will record audio when it records video. Otherwise, it will not record audio.

Notice: The default setting is that Audio input1 matches channel1 and Audio input2 matches channel2

If click , users could copy the setting of this channel to any other

selected channel.

### 7.4.3 Schedule configuration



Click the  icon and enter Schedule Configuration page as below:



Fig 7.15 Schedule configuration

There have three kinds of record modes: schedule record, motion detection and Sensor alarm record. We provide users to set schedules from Sunday to Monday separately for all of the three record modes. Sensor alarm recording mode has the highest priority among others.

When users need to edit schedule for a channel, select the camera name in the left Camera group firstly.

Click  icon and brush on the weekday schedule to add time; click  icon and click on the weekday schedule to delete time.

If click , users could copy the setting of this channel to any other selected channel.

### 7.4.4 Alarm configuration

Click  icon and enter into alarm configuration as show as below:

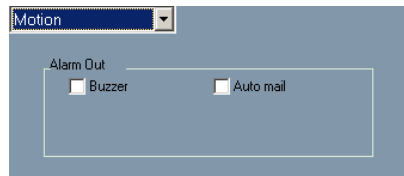

Fig 7.16 Alarm configuration

Users can set the alarm type: Motion and other. There are two alarms out options to choose from: Buzzer and Auto mail.

#### 1. Buzzer

Enable buzzer on board for alarm

#### 2. Auto mail

When alarm triggered, the system will send mail to users automatically.

If click , users could copy the setting of this channel to any other selected channel.

### 7.4.5 Record configuration

Click  icon and enter into record configuration interface as below:

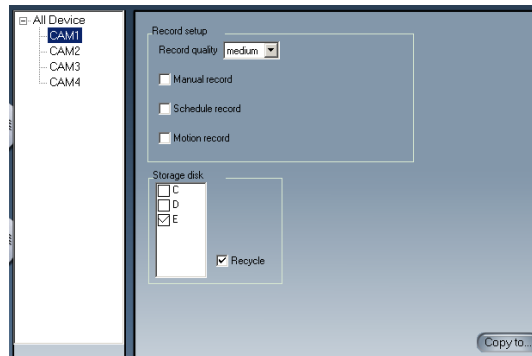

Fig 7.17 Record configuration

#### 1. Record setup

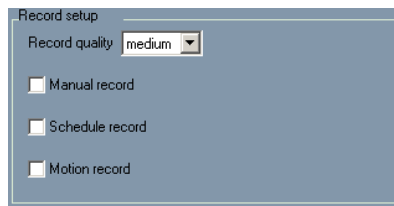

Fig 7.18 Record setup

According to different record triggering methods, users can set three kinds of record modes:

- Manual record

- Schedule record
- Motion record

Users can use multiple cameras to record, every camera works separately and record file also saves relatively.

a. Record quality

There are five modes can be selected from: lowest, lower, medium, higher and highest. Higher the record quality is, clearer the record image is.

b. Manual record

By selecting this option, the relative camera image will be recorded and saved all the time.

c. Schedule record

Schedule record option

d. Motion record

By selecting this option, users can set relative channels' record mode as motion detection.

2. Storage disk

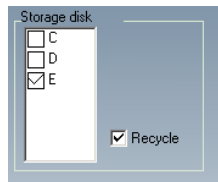



Fig 7.19 Storage disk

Users can store record file by selecting storage disk. Tick off 'Recycle' check box, users can set whether to continue recording to cover the earliest video file when the disc storing video files is full.

If click **Copy to...**, users could copy the setting of this channel to any other selected channel.

#### 7.4.6 Motion configuration

Click  icon and access to motion configuration interface as below:

Fout! Gebruik het tabblad Start om 标题 1 toe te passen op de tekst die u hier wilt weergeven. Fout!  
Gebruik het tabblad Start om 标题 1 toe te passen op de tekst die u hier wilt weergeven.

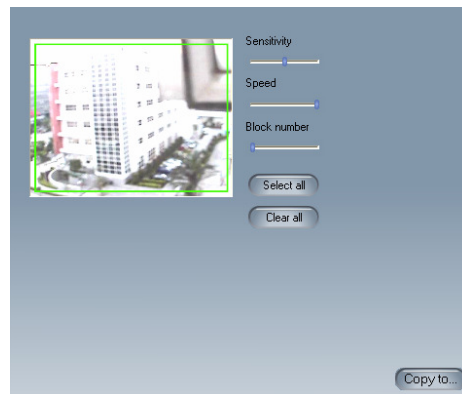

**Fig 7.20 Motion configuration**

Definition of the setup items:

1. Sensitivity

Users can set motion detection sensitivity here.

2. Speed

Motion detection sensitivity

3. Block number

Set grid's number

4. Select all

Select all the areas of the channel as detection area

5. Clear all

Clear all the detection areas and then users can select customized detection areas by cursor.

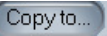
If click , users could copy the setting of this channel to any other selected channel.

#### 7.4.7 EMAIL Configuration

Click  icon and access to Email configuration interface:

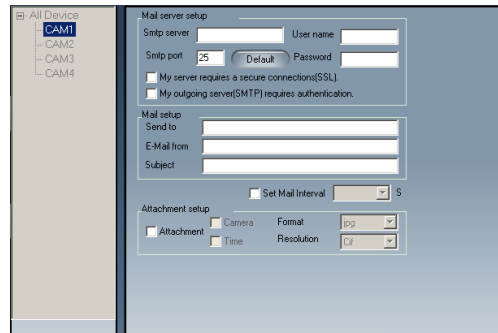

Fig 7.21 Email configuration

### 1. Mail server setup



Fig 7.22 Mail server setup

In this area, users can set receiver and sender's E-mail SMTP server and address. Note: the address of receiver and sender can be the same.

Relative Definitions:

Smtp server: Sender's SMTP, such as smtp.yahoo.com

User name: Sender's User Name

Smtp port: Mail server's port, the default value of mail server is25.

Password: Sender's Password

Users can select 'My server requires a secure connections' or 'My outgoing server (SMTP) requires authentication' check box according to server mail service of mail service supplier.

### 2. Mail setup



The 'Mail setup' dialog box contains three text input fields labeled 'Send to', 'E-Mail from', and 'Subject'. At the bottom, there is a checkbox labeled 'Set Mail Interval' and a dropdown menu currently showing '5'.

Fig 7.23 Mail setup

Relative Definitions:

Send to: Receiver's E-mail Address

E-Mail from: Sender's E-mail Address

Subject: E-mail Subject

Users can select 'Set Mail Internal' check box to set email send time, such as 5 seconds, 10 seconds and so on.

### 3. Attachment setup



The 'Attachment setup' dialog box features a checkbox for 'Attachment'. To its right are two checkboxes: 'Camera' and 'Time'. Further right are two dropdown menus: 'Format' (set to 'jpg') and 'Resolution' (set to 'Cif').

Fig 7.24 Attachment setup

Enable 'Attachment', then the present image will be sent to appointed mailbox when an alarm triggered.

Relative Definitions:

Camera: Channel Name

Time: Display Time

Format: Image Format

Resolution: Cif and QCif

### 7.4.8 P.T.Z Configuration

Click  icon then enter into the P.T.Z configuration as below:



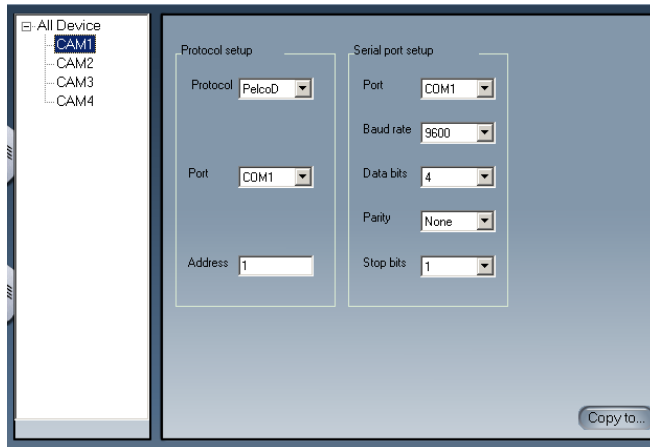

Fig 7.25 P.T.Z Configuration

1. Protocol setup

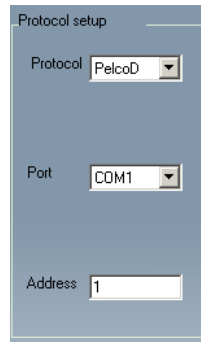

Fig 7.26 P.T.Z Protocol setup

A. Protocol

Communication protocol of P.T.Z device

B. Port

Users can set serial port number

C. Address

Communication address of P.T.Z device

2. Serial port setup

Users should firstly enable the P.T.Z control function of certain camera and select a port number in P.T.Z Protocol Setup (refer to Fig7-26), and then set corresponding parameters in the area below:

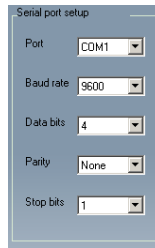

Fig 7.27 P.T.Z Serial port setup

A. Port

Users can set port number

B. Baud rate

Set P.T.Z device Baud rate, default value is 9600

C. Data bits

Default value is 8

D. Parity

Odd and even parity bit, default Null

E. Stop bits

Default value is 1

**Notice: Users should look into the P.T.Z device and get Baud rate, Protocol and Address firstly, and then set other values accordingly.**

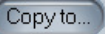
If click , users could copy the setting of this channel to any other selected channel.

## 7.5 Mobile Surveillance

### 7.5.1 Introduction to Mobile Surveillance

In SuperDVR system, the mobile surveillance can be realized by connecting the mobile phone to the system. For time being, the function is supported by Windows Mobile system and Symbian Series 60 Developer Platform 2.0 intelligent mobile phone system.

So far, the types of phones on which the function has been tested are shown

as below table.

Parameter Brand	TYPE	SYSTEM
DOPOD	Dopod 696	Windows Mobile 2003
	Dopod 818	Windows Mobile 2003
	Dopod 828+	Windows Mobile 2003
	Dopod 838 Pro(3G)	Windows Mobile 5.0
O2	O2 Xda II	Windows Mobile 2003
	O2 Xda Atom(3G)	Windows Mobile 5.0
	O2 Xda Mini	Windows Mobile 2003
NOKIA	Nokia N70	S60 OS8.1a
	Nokia N73	S60 OS9.1
	Nokia N80	S60 OS9.1
	Nokia N-Gage	S60 OS6.1
	Nokia 3230	S60 OS7.0s
	Nokia 3250	S60 OS9.1
	Nokia 6260	S60 OS7.0s
	Nokia 6630	S60 OS8.0s
	Nokia 6680	S60 OS8.0s
	Nokia 7610	S60 OS7.0s
NOKIA	Nokia N-95	S60 OS9.2

Table 7-1 Mobile Phone of Supporting Mobile Surveillance

### 7.5.2 Client Configuration of Windows Mobile

Server configuration on SuperDVR needs to be set before the function on phone is activated. Please refer to Section 'Remote Live Surveillance'.

#### Client Configuration of Symbian 60:

Step1: Firstly, enable the network access on mobile phone and then run 'Web browser after the server configuration has been done.

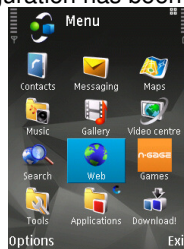

Fig 7.28 Open Web Brower

Step2: Input the server address in a new-built bookmark. Click this bookmark to connect to the server.

Fout! Gebruik het tabblad Start om 标题 1 toe te passen op de tekst die u hier wilt weergeven. Fout!  
Gebruik het tabblad Start om 标题 1 toe te passen op de tekst die u hier wilt weergeven.

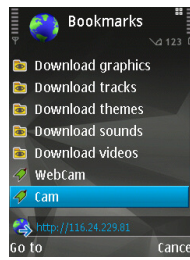

Fig 7.29 Build a bookmark

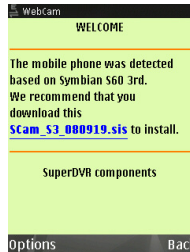

Fig 7.30 Connect to Server

Step3: Click 'Scam\_S3\_080919.sis' to start downloading and a confirmation information window will pop up after downloading is finished.

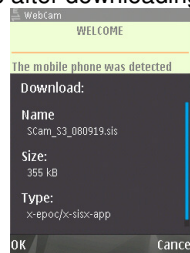

Fig 7.31 Confirmation Information Window

Step4: Click 'OK', the system reminds of whether to install the 'Webcam'.

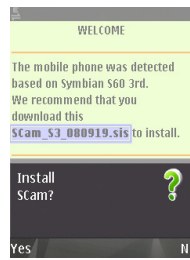

Fig 7.32 Installing Configuration Information

Step5: Click 'Yes' to start installing. A Scam shortcut icon appears on the system menu after the installation has been done.



Fig 7.33 Scam Shortcut icon in System Menu

Step6: Run 'Scam' by selecting the icon:

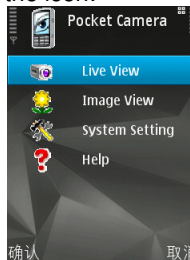

Fig 7.34 Main Layout of Scam

Step7: Enter the main menu by selecting 'Live View' .A Setting window will pop up and select 'Login Setting ' to login.

**Notice:** In this interface, select 'Image View' users can browser and preview the snapped pictures , 'System Setting' means in case, an alarm triggered, the alarm signal will pop up automatically to users' mobile phone whenever their made other operations in the background.



Fig 7.35 Configuration Login Information

HttpPort: server-side software to set the http port number, the default port number is 80. Click 'Options' and enters into advanced setting window.

**Notice: The default User name is SYSTEM without password. Users can set user name and password at the server end.**

Step8: Click Options to login, the live mobile surveillance is show as below:



Fig 7.36 Log in Successfully

Step9: Return to 'Setting' interface, select 'Alarm Setting' a dialogue will appear as below, users can select items of alarm setting in needed.

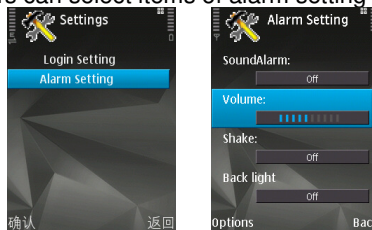

Fig 7.37 Alarm Setting

Sound Alarm: Sound alarm

**Note: The software is running in the background, what kind of methods (sound alarm or vibration tips) that users want to be informed when an unusual occurs in remote site.**

Volume: adjust the sound

Back light: background light for Normal open

**Note: By default, the mobile phone didn't do anything for 10 seconds, the back light of phone screen will be shut down in which causes great inconvenience to users for viewing site images in a long time, so open the back lights have been provided almost.**

## Appendix1 Frequently Asked Questions

### Appendix 2.1 Installation

#### Appendix 2.1.1 Cannot Install the SuperDVR Driver

Possible causes:

- TD series capture card has not been installed. Before installing driver, users should install capture card hardware in the PCI slot in the computer case.
- TD series capture card has not been installed correctly. Please unplug the card and install it again or change to another PCI slot.
- Not compatible with PC hardware

#### Appendix 2.1.2 Why cannot run SuperDVR at the windows 2003 operate system?

Enabled Hardware Acceleration and DirectX Acceleration:

- Hardware Acceleration

**STEP1:** Right-click the mouse on the desktop, then select 'Properties→Setting→Advanced→Trouble Shooting'.

**STEP2:** Drag the acceleration bar to 'Full'.

**STEP3:** Click 'OK' to save the modification.

- DirectX Acceleration

**STEP1:** Click 'Start → Run', it will pop up 'Run' window.

**STEP2:** Input 'dxdiag' and click 'OK'.

**STEP3:** Select 'Yes' in the pop-up dialog box, it will pop up 'DirectX Tools' window.

**STEP4:** Select 'Display' option.

**STEP5:** Click the three buttons-'DirectDraw', 'Direct3D' and 'AGP Texture'.

**STEP6:** Click 'Exit' to exit the 'Directx Tools' window.

#### Appendix 2.1.3 Can't find TD series Devices in Device Manager

Enter the Device Manager and cannot find corresponding TD series Devices, the possible cause may be as below:



- Windows system error. Restart computer.
- TD series card error. Change for a valid one.
- Install SuperDVR.

## Appendix 2.2 How to Use SuperDVR

### Appendix 2.2.1 Meanings of the indicator lights

- Grey- Normal state
- Red - Sensor alarm
- Yellow - Motion detection alarm
- Blue - Video loss
- Bottle Green - Manual record state
- Reseda - Schedule record state

#### NOTICE

Users can refer to Figure3-6 to learn more.

### Appendix 2.2.2 How does the different record mode work?

Users can set more than one record modes in Record setup (refer to Figure3-5), but actually, there is only one valid record mode for recording.

The priority order of the record modes is: Sensor Alarm Record > Motion Detection Record > Manual Record > Schedule Record

### Appendix 2.2.3 How to set recycling record mode on the system

Select 'Recycle' in basic configuration, refers to Figure4-1.

Users can select the percent of used disk space to set up "disk shortage alarm." You can input percent manually or choose the selectable given items such as, 25%, 50%, and 75% to set up. For example, if selecting 50%, it will alarm to warn that your disk space has already been used 50%.

#### TIPS

It is recommended that install SuperDVR into the partition installed with windows system (normally C:), and save record files in HDD partition D: .

### Appendix 2.2.4 How to set auto reboot function

In case, Microsoft Windows system continuously runs for a couple of days. The system may become unstable; therefore, it is suggested to restart the computer every few of days.

In the basic configuration (refer to Figure4-1), input Windows user name and password (It is not SuperDVR user name and password), and select time interval, then the Windows system will automatically restart according to the set time.

In case the Windows system closed abnormally, i.e. power supply is cut off,

and when computer reboot next time, SuperDVR system will automatically restart, and keep the settings as before.

**TIPS**

Users do not need enable auto reboot function, but it's suggested to input the Windows user name and password in the relative area, therefore when meeting abnormal system exit, users don't need to be troubled to input Windows and SuperDVR user names and passwords.

**Appendix 2.2.5 How to quickly use the schedule record function**

Press '**Shift**' or '**Ctrl**' key, and draw the cursor in corresponding areas to make schedules for multiple channels.

**Appendix 2.2.6 What are the byte rates for different image qualities from highest to normal?**

When on PAL system and the frame rate is 25 fps, bit rate for the highest image quality is about 120K Byte/s, and for the lowest image quality is about 30K Byte/s.

**Appendix 2.2.7 The frame rate seems to be lower than what I set?**

There is frame loss in image switch therefore the real record frame rate is about relatively lower than the theoretic value.

**Appendix 2.2.8 Why I can't select more channels to backup?**

Please draw the mouse in the channel selection area, or utilize Shift and Ctrl key for assistance.

## Appendix 2.3 How to Use Network Function

**Appendix 2.3.1 How to monitor on the client-side**

First enable '**Web cameras service**' in basic configuration (refer to Figure4-1).

Input the server Internet address in IE browser on the client-side, and the necessary web cam driver will be downloaded automatically, and then users need to install the driver. After access the web cam main interface, click '**Login**' and input user name and password to log in the system.

**Appendix 2.3.2 Why I can't download the client-side software?**

The possible causes:

- The client-side computer has not properly connected to Internet or LAN.
- The server-end has not enabled '**Web Cameras Service**'.
- The default Http port is 80. It may be conflict with other Web servers, for example IIS. If true, please change another port.

- Windows XP SP2 will block the OCX download. You should enable 'Internet Option → Security Settings → Download unsigned ActiveX controls'.

### **Appendix 2.3.3 Why can't the server be configured at the client-side?**

The possible causes:

- It cannot be configured at the client-side, when the server is being configured at the server-end.
- Only the last configuration is valid if server different configuration are deployed simultaneously.

### **Appendix 2.3.4 Why I can't see the images?**

The possible causes:

- The VGA card is too outdated.
- Have not installed newer DirectDraw.
- SuperDVR cannot run in Window 98 system.
- Data port or command port is conflicts with other network services.
- The user is connected to Internet through LAN, and the network administrator has not enabled corresponding data port or command port.
- The client-side has installed firewall software that may stop video transmission.
- H.264 codec has not been installed properly, please download new version WebCam.
- Slow network speed.

### **Appendix 2.3.5 What should I do if the Internet speed is quite slow?**

The more channels opened, and the slower the video transmission speed, therefore try to use one channel display mode when the network speed is slow.

#### **TIPS**

There may be some surplus channels that have no video input. Switching off the channels is of help to improve transmission speed. (Refer to '4.1 Basic Configuration' about switching on/off channels.)

### **Appendix 2.3.6 Why I can't start WebCam server or RPB server?**

Possible causes:

Other software is using these ports. If so, please change WebCam ports configuration or stop other softwares.

## Appendix 2.4 Other Questions

### Appendix 2.4.1 Why computer display doesn't work, and why I can't access window system?

The capture card may not be well installed. Unplug the card and try it again.

**NOTICE**

Please unplug the power plug of the computer, so as to avoid damaging the motherboard chip set.

### Appendix 2.4.2 Why I can't find the recorded files?

HDD space is not enough.

### Appendix 2.4.3 Why the screens display is unstable with dithering and water-wave images?

Possible causes:

- Camera electrical power is not enough.
- There is external electromagnetic disturbance, or electrostatic disturbance of camera BNC connector (It is suggested to connect ground wire to the connector).
- User has not installed necessary VGA driver.
- VGA card problem. Try reinstalling the VGA card, or changing another VGA card.

### Appendix 2.4.4 Why does it delay to play back, and it's slow to close and open the driver?

Possible causes:

- Windows system problem. Try to reboot the computer.
- There are too many recorded files or too many fragments on the HDD, therefore it takes time to search for the files, you need delete the files that you don't need, or need to make disk defragmenter now.
- Capture card problem.
- Computer hardware system is too outdated.

### Appendix 2.4.5 Why I can't play back?

Windows media player has been damaged, or decoder has not been installed properly. It is suggested to reinstall the relative software system.

Computer problem, recorded files have been damaged. It is suggested to fix these files using SuperAVIFix program.

### Appendix 2.4.6 Why do I see some gray blocks on time progress bar area when play back?

Possible causes:

- User has deleted these recorded files.

- SuperDVR has deleted recorded file when recycle option being is chosen.
- Recorded files cannot be opened because the recording is on.

#### **Appendix 2.4.7 Why could I see some old record sections that didn't be covered when playing back?**

Possible causes:

- You have ever selected disk partitions different from the current.
- These recorded files are being played back when covering it.
- Database of recorded log was damaged.
- You have ever installed SuperDVR on different directories.

#### **Appendix 2.4.8 Precautions on changing system time**

- The superDVR system provides the retrieving mechanism for video files, which must take the system time as a retrieving reference. To change the computer time after installation will create a high risk of wrong time reference.
- Before superDVR is used, it must be confirmed whether the current computer time is correct.
- Deactivate computer auto time updating function of system.
- Make sure the motherboard of the computer is in normal state.

#### **Appendix 2.4.9 If system time must be changed, please do following preparations first**

1. If new time is later than current computer time (for example, change 2006/01/01 0: 0: 0 (current system time) to 2007/01/01 0: 0: 0 (target time)), the change can be made directly.
2. If new time is before the current computer time (for example, change 2007/01/01 0: 0: 0 (current system time) to 2006/01/01 0: 0: 0 (target time)), first stop the video recording, backup all video data. Turn off superDVR, change computer time, and re-start SuperDVR.

#### **Appendix 2.4.10 How to use REPAIRDB to repair SuperDVR database**

Enter the installation directory of SuperDVR.

C:\ProgramFiles\SuperDVR\SuperDVR,open the REPAIRDB.EXE file. The user ID is 'SYSTEM', and no password is needed to enter. After entering, please select database to repair.

#### **Appendix 2.4.11 How to set power options of Microsoft VISTA system**

After install VISTA system, you should enter the Start menu to choose 'Control Panel'. Select 'System and Maintenance' link. And select 'Power' option in 'System and Maintenance' window. Lastly, Select the 'High Performance Change Plan Setting' option.

#### **NOTICE**

The digital video capture cards support Intel CPU on VISTA edition.

## Appendix2 Quick Start for Using

### Appendix 3.1 Requirements

Before installing the PCI card, check PC requirements:

- Pentium 2.8 GHZ
- 512 MB RAM
- Windows 2000 (SP4 min) or Win XP (SP2 min)
- NVIDIA Video Card with 64 MB min or similar
- DirectX 9.0 minimum
- 80 GB HDD

**NOTICE**

TD3104 and TD3316 support Windows 2000(SP4 min) or Windows XP(SP2 min).

### Appendix 3.2 Installation Instructions

**STEP1:** Insert the PCI card (But do not connect the Camera yet).

**STEP2:** Launch windows.

**STEP3:** Windows will come up with Hardware wizard. Just click '**Cancel**'.

**STEP4:** Put the installation CD in and open up SuperDVR folder run the 'Setup' file.

**STEP5:** Follow the steps and in Windows XP, it will come up with a message say this program has not passed windows logo testing, just 'Continued anyway'.

**STEP6:** Reboot computer once it is completed.

For complete instructions, refer to user manual 1-7 chapters.

Once Boot up, On Desktop there will be 'SuperDVR' icon.

If this program recognizes the PCI card, program will open just fine. Please log in first to the program.

Once your program is opened, now connect the Camera.

## Appendix 3.3 Troubleshooting

### Appendix3.3.1 When opening the SuperDVR program, it says ' Can't find card '.

Reboot one more time. If still same problem, click 'Start - Program - SuperDVR - Install' and then uninstall the program. Reboot the computer. After reboot, go back to 'Start - Program - SuperDVR - Install'. Now click on '**Install**' to reinstall driver. Then Reboot.

If for some reason still 'Can't find card ', uninstall driver again. Shut down the computer. Move PCI Card to another slot. Reboot it. And click '**Cancel**' when windows detect it.

Then reinstall driver by going to 'Start - Program - SuperDVR - Install'.

For other setting in the program, please read user manual 1-7 chapters.

### Appendix 3.3.2 How to setup the web client to monitor from Internet

1. On Main Computer where DVR Card Installed

**STEP1:** Make sure the computer connected to Internet. DSL or Cable Modem preferably.

**STEP2:** Find out your IP address. You can go to this link to find the IP address <http://lawrencegoetz.com/programs/ipinfo/>.

**STEP3:** Open up the SuperDVR program and go to basic configuration. Check and ENABLE Web Camera Service and Remote Play Back Service.

**STEP4:** Make Note on Data Port, Command Port and RPB port.

#### NOTICE

If you are connecting to internet using router, you need to configure the setup of the router and do the port forwarding. Ports that need to be forwarded: 80, 1159, 1160 and 1161. Check your router manual on how to setup that.

2. On Remote Client Computer

**STEP1:** Minimum Requirement for the client computer:

- Pentium 2.8 GHZ
- 512 MB RAM
- Windows 2000 (SP4 min) or Win XP (SP2 min)
- NVIDIA Video Card with 64 MB min or similar
- DirectX 9.0 minimum
- 80 GB HDD

**STEP2:** Open up Internet Explorer.

If you are running XP with SP2 follow the steps then: on Internet explorer, click 'Tools - Internet Option - Security - Custom Level', and enable '**Download unsigned ActiveX controls**'.

**STEP3:** In the IE textbox of the Internet explorer, input the IP address of Main Computer.

**STEP4:** Select '**Live Surveillance**' and click '**OK**' on displayed page.

This will download the webcam program. And then you can download Remote Playback as well.

**STEP5:** On Desktop now you should see 'WebCam' and 'Remote Playback' icon.

**STEP6:** Open up webcam, click '**Key**' symbol icon.  
Username: system (Password blank unless you setup a password within the main computer).  
Server: this the IP address of the Main Computer.  
Data port: 1159 and Command port: 1160.

**STEP7:** Click '**OK**'. Now you should be able to view the live video from main computer.

**STEP8:** To play back the Video that has been recorded in Main Computer, Select '**Remote Playback**' on displayed page.

**STEP9:** Click on '**Config**'.  
Remote server: the IP address of main computer.  
IP port: 1161.

**STEP10:** Then click '**OK**'.

**STEP11:** Click '**Login**'. Now you should be able to play back the recorded video from Main Computer.

For more details information, please read user manual 1-7 chapters.



## Appendix3 Function Tree

### Appendix 4.1 SuperDVR Function Tree

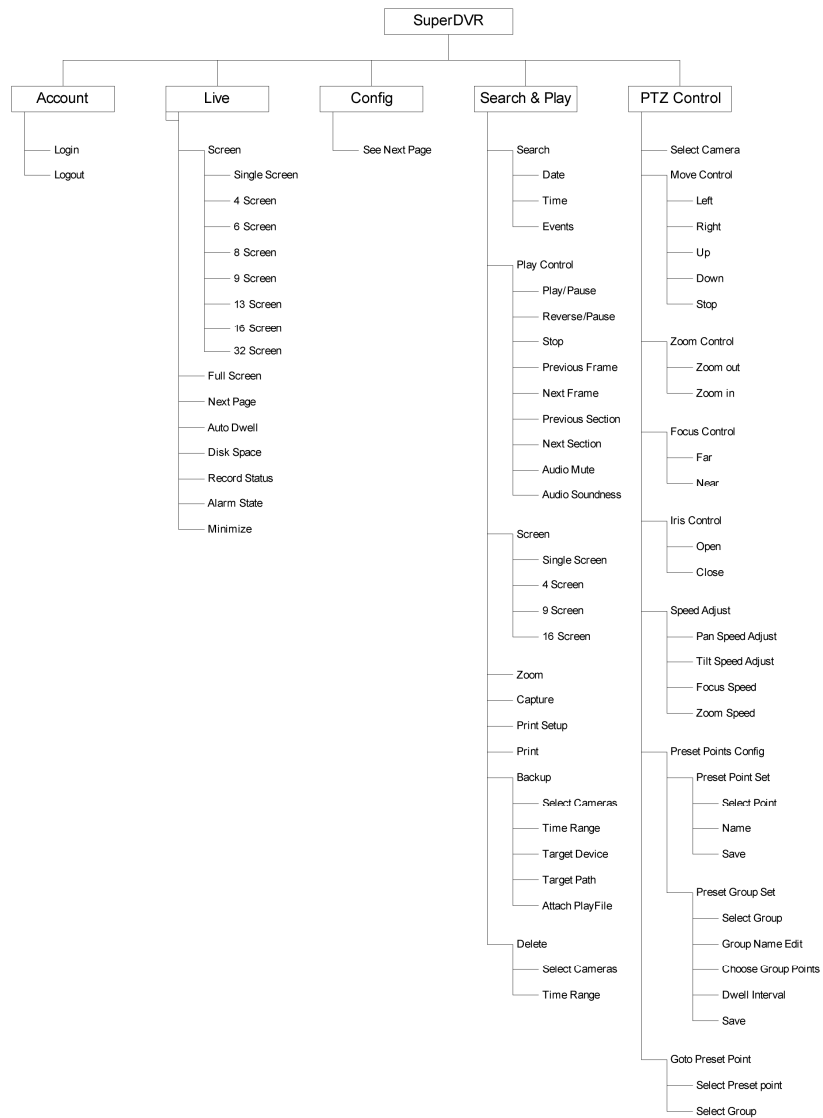

Tree1 SuperDVR Function

# Appendix 4.2 System Configuration Tree

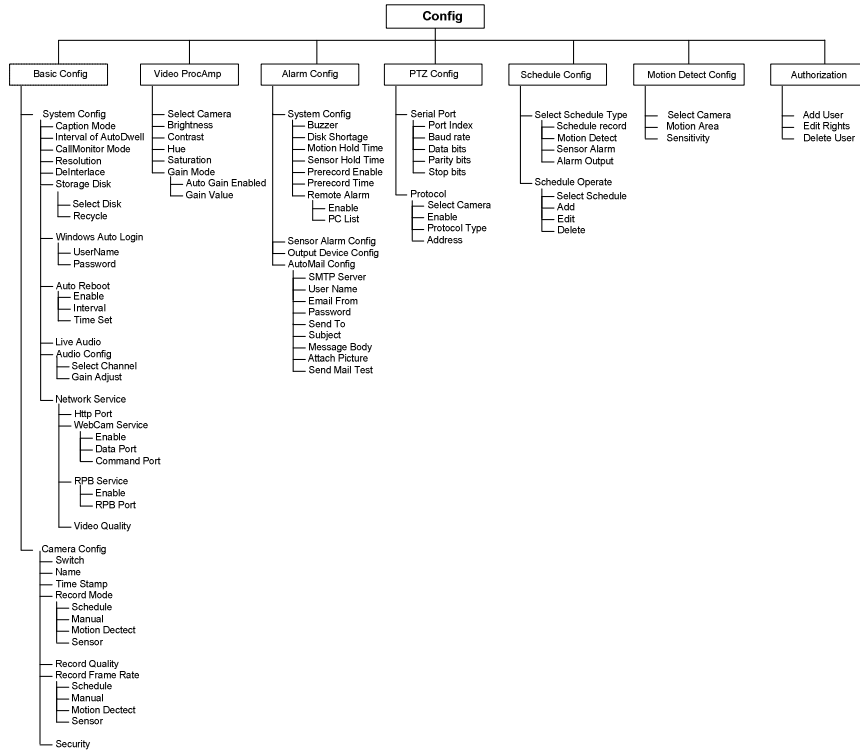

Tree2 System Configuration

## Appendix 4.3 IE Client Function Tree

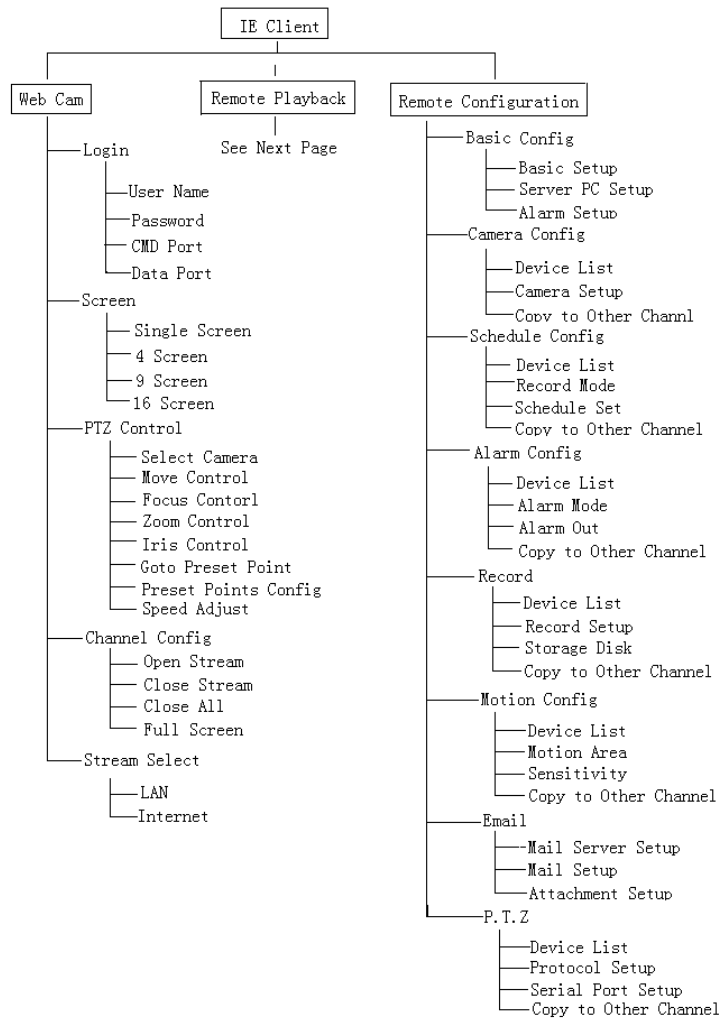

Tree3 IE Client Function

## Appendix 4.4 Remote Playback Function Tree

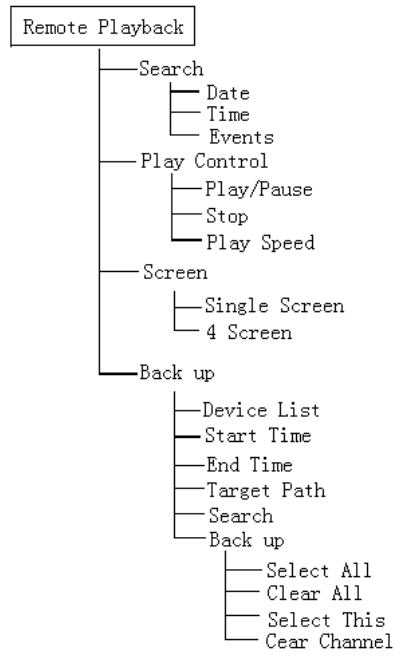

**Tree4 Remote Playback Function**